



University of
Zurich^{UZH}

EBPI Epidemiology, Biostatistics and Prevention Institute

Transformation Forests

Torsten Hothorn

Joint work with Achim Zeileis, Lisa Schlosser and Heidi Seibold

Machine Learning

Machine Learning methods give

computers the ability to learn without being explicitly programmed.

(Arthur Samuel, 1959)

Actually: Fit statistical models to data by clever optimisation of appropriate target functions

Statistical Learning

An oxymoron, like “Statistical Science”

Either you learn, or you estimate

Statistical Modelling

Too dull a term to attract any grant money

However: Explicitly acknowledges the underlying probabilistic theory

Statistical Models

What is a statistical model?

$$Y \sim \mathbb{P}_Y$$

What is a regression model?

$$Y \mid \mathbf{X} = \mathbf{x} \sim \mathbb{P}_{Y \mid \mathbf{X} = \mathbf{x}}$$

Random Forest

What is a random forest (in general, not only B&C)?

Classical:

$$\mathbb{E}(Y | \mathbf{X} = \mathbf{x}) = f(\mathbf{x}), \quad \forall \mathbf{x} \in \mathcal{X}$$

Here:

$$\mathbb{P}(Y \leq y | \mathbf{X} = \mathbf{x}) = \mathbb{P}_{Y|\mathbf{X}=\mathbf{x}}(y) = f(y | \mathbf{x}), \quad \forall \mathbf{x} \in \mathcal{X}$$

Parametric (!) Setup

Unconditional model for response

$$\mathbb{P}_{Y,\Theta} = \{\mathbb{P}_{Y,\vartheta} \mid \vartheta \in \Theta\}$$

Assumption: Regression model belongs to this family:

$$\mathbb{P}_{Y|\mathbf{X}=\mathbf{x}} = \mathbb{P}_{Y,\vartheta(\mathbf{x})}$$

Task: Estimate ϑ function

Likelihood Contributions

“Learning” data (y_i, \mathbf{x}_i) , $i = 1, \dots, N$ plus family $\mathbb{P}_{Y, \Theta}$ defines likelihood function

$$\ell_i : \Theta \rightarrow \mathbb{R}$$

$\ell_i(\vartheta(\mathbf{x}_i))$ gives the likelihood for observation i with candidate parameters $\vartheta(\mathbf{x}_i)$

Handle censoring and truncation appropriately here

Adaptive Local Likelihood Estimators

$$\hat{\vartheta}^N(\mathbf{x}) := \arg \max_{\vartheta \in \Theta} \sum_{i=1}^N w_i^N(\mathbf{x}) \ell_i(\vartheta)$$

Conditioning works via weight functions $w_i^N(\mathbf{x})$ only

Unconditional Maximum Likelihood

$$\hat{\vartheta}_{\text{ML}}^N := \arg \max_{\vartheta \in \Theta} \sum_{i=1}^N \ell_i(\vartheta)$$

Trees

$$\mathcal{X} = \dot{\bigcup}_{b=1, \dots, B} \mathcal{B}_b$$

$$w_{\text{Tree},i}^N(\mathbf{x}) := \sum_{b=1}^B I(\mathbf{x} \in \mathcal{B}_b \wedge \mathbf{x}_i \in \mathcal{B}_b)$$

$$\hat{\vartheta}_{\text{Tree}}^N(\mathbf{x}) := \arg \max_{\vartheta \in \Theta} \sum_{i=1}^N w_{\text{Tree},i}^N(\mathbf{x}) \ell_i(\vartheta)$$

Forests

$$\mathcal{X} = \bigcup_{b=1, \dots, B_t}^{\bullet} \mathcal{B}_{tb} \text{ for } t = 1, \dots, T \text{ trees}$$

$$w_{\text{Forest},i}^N(\mathbf{x}) := \sum_{t=1}^T \sum_{b=1}^{B_t} I(\mathbf{x} \in \mathcal{B}_{tb} \wedge \mathbf{x}_i \in \mathcal{B}_{tb})$$

$$\hat{\vartheta}_{\text{Forest}}^N(\mathbf{x}) := \arg \max_{\vartheta \in \Theta} \sum_{i=1}^N w_{\text{Forest},i}^N(\mathbf{x}) \ell_i(\vartheta)$$

OK, Done! Really?

These “nearest neighbor weights” have been used before, first in

- “bagging survival trees” (2004), in
- “conditional inference forests” (**party(kit)**, since 2005) and in
- “quantile regression forests” (**quantregForest**, since 2006)

with *standard* trees (CART- or CTree-like).

Unfortunately, there is a catch.

The Problem

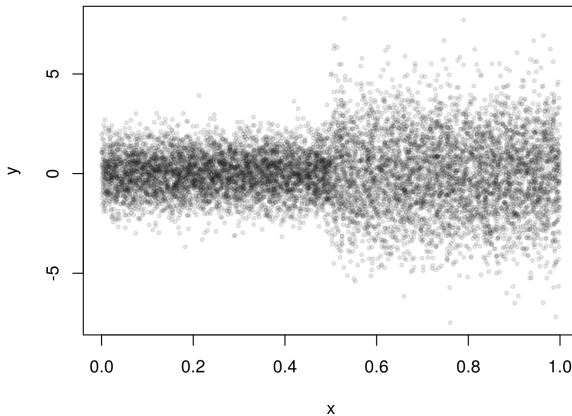

The Problem

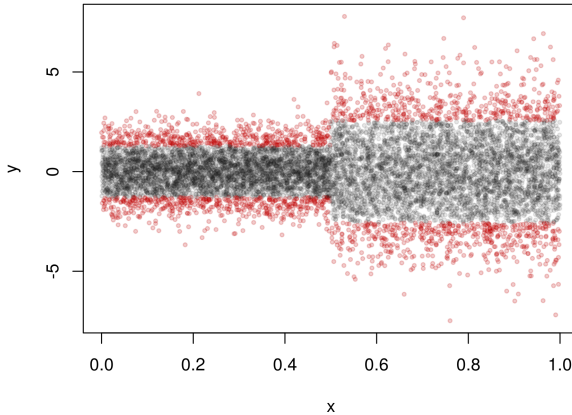

The Problem

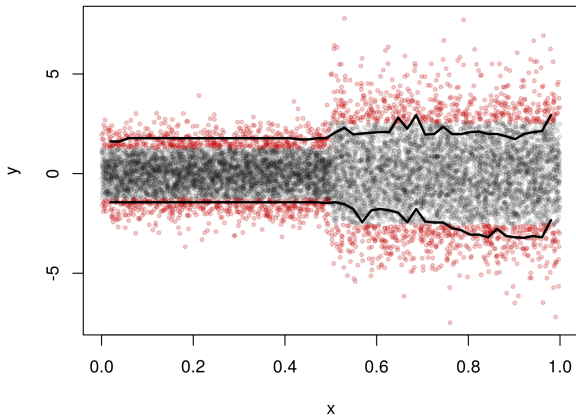

The Problem

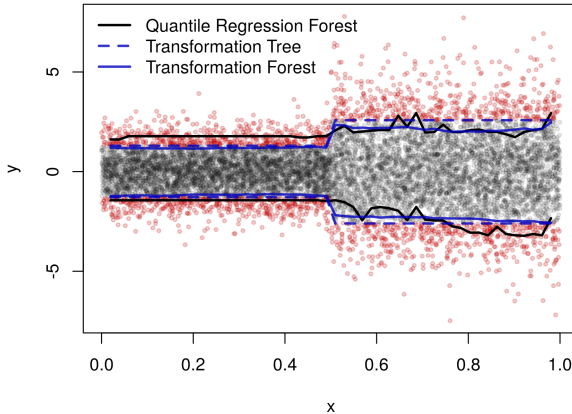

The Solution

We need splits sensitive to *distributional* and not just *mean* changes.

Generic approach (“Distribution trees and forests”):

$$\mathbb{P}(Y \leq y \mid \mathbf{X} = \mathbf{x}) = \mathbb{P}_{Y, \vartheta(\mathbf{x})}(y)$$

Here: Use transformation model

$$\mathbb{P}(Y \leq y \mid \mathbf{X} = \mathbf{x}) = \Phi(\mathbf{a}_{\text{BS},d}(y)^\top \vartheta(\mathbf{x}))$$

Transformation Models

$$\mathbb{P}(Y \leq y \mid \mathbf{X} = \mathbf{x}) = \Phi(\mathbf{a}_{\text{Bs},d}(y)^\top \boldsymbol{\vartheta}(\mathbf{x}))$$

- $\mathbf{a}_{\text{Bs},d}(y)^\top \boldsymbol{\vartheta}(\mathbf{x})$ is a smooth, monotonic Bernstein polynomial of degree d
- $d = 1$ means $\mathbb{P}_{Y|\mathbf{X}=\mathbf{x}} = \mathcal{N}(\mu(\mathbf{x}), \sigma^2(\mathbf{x}))$
- $d = 5$ is surprisingly flexible

Why this parameterisation? No need to code the whole Johnson & Kotz.

Model-based Recursive Partitioning (MOB)

Core idea

- Fit parameters $\hat{\vartheta}_{\text{ML}}$ in *unconditional* model $\mathbb{P}_{Y, \vartheta}$
- Compute individual gradient contributions (“scores”)

$$\mathbf{s}_i = \left. \frac{\partial \ell_i(\vartheta)}{\partial \vartheta} \right|_{\vartheta = \hat{\vartheta}_{\text{ML}}}$$

- Select predictor from \mathbf{x} with strongest parameter instability as indicated by highest association to $\mathbf{s}_i, i = 1, \dots, N$
- Find “best” binary split; repeat recursively

Implemented for many models, including (G)LM(M)s, parametric survival, β -regression, spatial lag, Bradley-Terry-Luce, various Item Response Theory models, subgroup analyses, etc.

Transformation Trees (TTree)

- Start with $\hat{\vartheta}_{ML}^N$
- Search for parameter instabilities in $\hat{\vartheta}_{ML}^N$ as a function of \mathbf{x} using (a beefed-up version) of MOB
- Potentially find changes in the mean AND higher moments
- Forests: Aggregate these trees via adaptive local likelihood estimation

Transformation Forests (TForest)

$$\hat{\mathbb{P}}(Y \leq y \mid \mathbf{X} = \mathbf{x}) = \Phi(\mathbf{a}_{Bs,d}(y)^\top \hat{\boldsymbol{\vartheta}}_{\text{Forest}}^N(\mathbf{x}))$$

makes the forest “parametric” (one model for each \mathbf{x}) with

- Forest likelihood
- Prediction intervals
- Likelihood-based variable importance
- Parametric bootstrap
- ...

and applicable to censored and truncated data.

Swiss Body Mass Index Distributions

2012 survey ($N = 16427$) in Switzerland

Explain conditional distribution of BMI given

- Sex,
- Smoking status,
- Age,
- Education,
- Physical activity,
- Alcohol intake,
- Fruit and vegetable consumption,
- Region, and
- Nationality.

BMI by Sex and Smoking

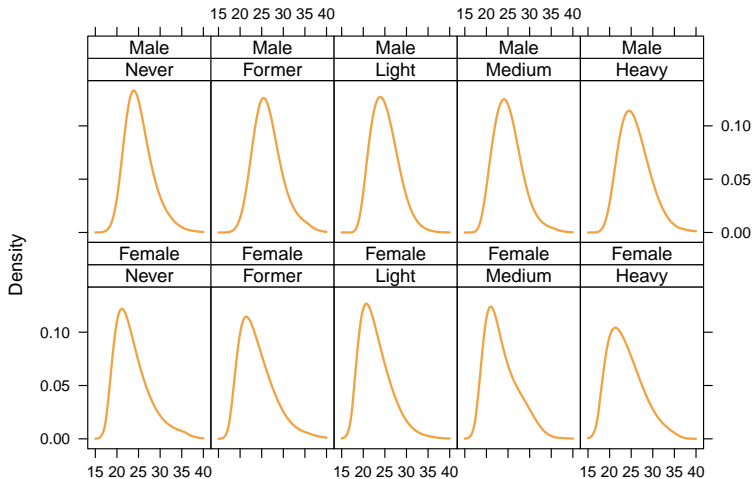

Log-likelihood: -43564.30 BMI

Transformation Tree

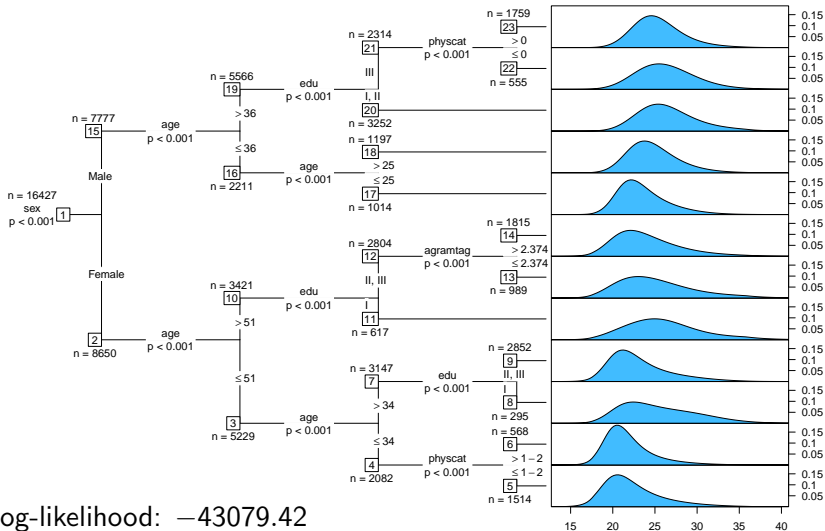

Transformation Forest: Variable Importance

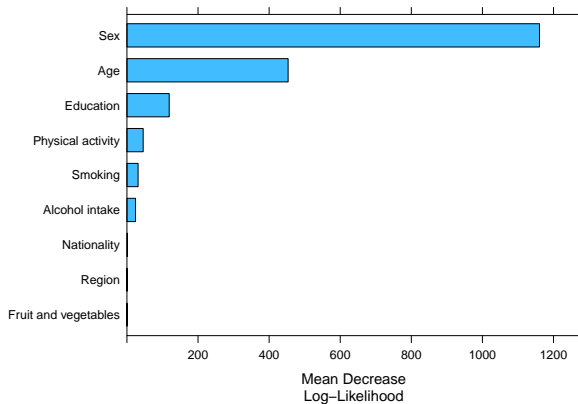

Log-likelihood: -42520.18

Transformation Forest: Partial Deciles

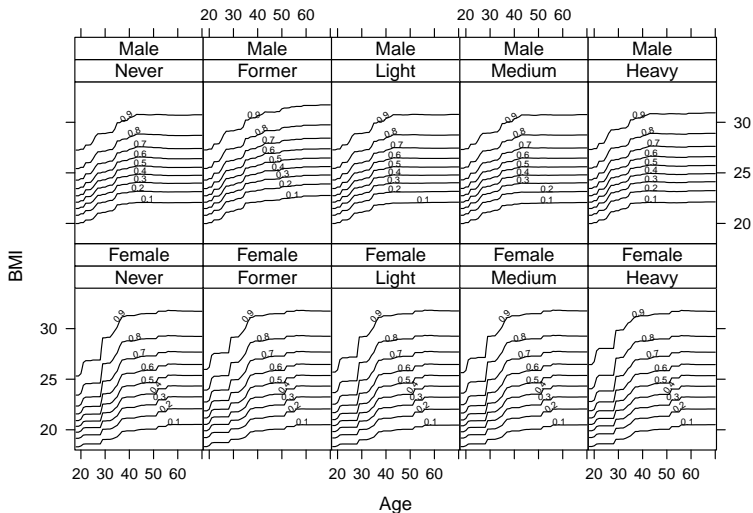

More Complex Models

For example: Subgroup analysis, stratified / personalised medicine, ...

Conditional transformation model

$$\mathbb{P}(Y \leq y \mid \text{treatment}, \mathbf{X} = \mathbf{x}) = F_Z(\mathbf{a}_{B_s, d}(y)^\top \boldsymbol{\vartheta}(\mathbf{x}) - \beta(\mathbf{x})I(\text{treated}))$$

- Both the “intercept function” $\mathbf{a}_{B_s, d}(y)^\top \boldsymbol{\vartheta}(\mathbf{x})$ and
- the treatment effect $\beta(\mathbf{x})$ may depend on \mathbf{x}
- $F_Z() = 1 - \exp(-\exp())$ makes β a log-hazard ratio
- Include $\hat{\beta}$ in search for parameter instabilities

Stratified Medicine

Partition log-hazard ratio β from a fully parametric Cox model

$$\mathbb{P}(T > t \mid \text{treatment}) = \exp(-\exp(\mathbf{a}_{Bs,d}(t)^\top \boldsymbol{\vartheta} - \beta I(\text{treated})))$$

for a randomised controlled clinical trial on hormonal treatment of breast-cancer patients

```
> library("tram") ### R-forge/ctm
> cmod <- Coxph(ctime ~ horTh, data = GBSG2)
> library("trtf") ### CRAN
> tmod <- trafotree(cmod,
+                   formula = ctime ~ horTh | .,
+                   data = GBSG2)
```

Stratified Medicine

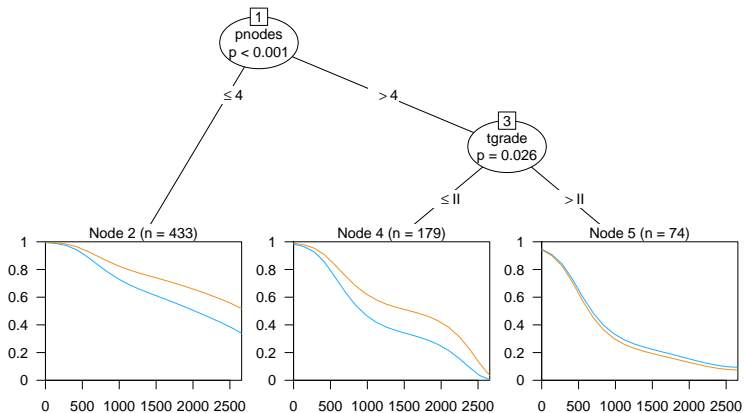

Discussion

- The “two cultures” of statistical modelling come closer
- With $Y = \text{BMI, rain, house prices, survival time etc.}$

$$\hat{\mathbb{E}}(Y|\mathbf{X} = \mathbf{x}) = \hat{f}(\mathbf{x}) = \mathbf{x}^\top \hat{\beta}$$

not interesting (or even harmful)

- $\mathbb{P}_{Y, \hat{\vartheta}(\mathbf{x})}$ more informative
- Flexibility (non-linear interactions) of B&C random forests preserved
- Simplicity of B&C random forests preserved
- Large sample behaviour?
- High dimensional?

Low and High

$$Y \sim N(\mu(\mathbf{x}), \sigma^2(\mathbf{x}))$$

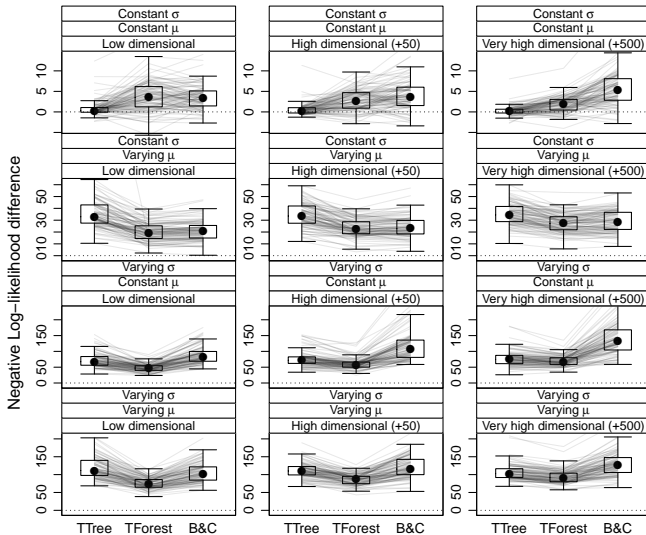

Resources

- “Transformation Forests”, **trtf**,
<https://arxiv.org/abs/1701.02110>,
- “Top-Down Transformation Choice” (with BMI example),
SM, **trtf**, <http://arxiv.org/abs/1706.08269>
- “Most Likely Transformations”, SJoS, **mlt**, **tram**,
<http://dx.doi.org/10.1111/sjos.12291>
- “Conditional Transformation Models”, JRSS-B,
<http://dx.doi.org/10.1111/rssb.12017>
- “Model-based Recursive Partitioning”, JCGS, **partykit**
<http://dx.doi.org/10.1198/106186008X319331>,
- “Model-based Recursive Partitioning for Subgroup
Analyses”, IJB, **model4you**
<http://dx.doi.org/10.1515/ijb-2015-0032>
- “Model-based Forests”, SMMR, **model4you**,
<http://dx.doi.org/10.1177/0962280217693034>

Low and High: Median

$$Y \sim N(\mu(\mathbf{x}), \sigma^2(\mathbf{x}))$$

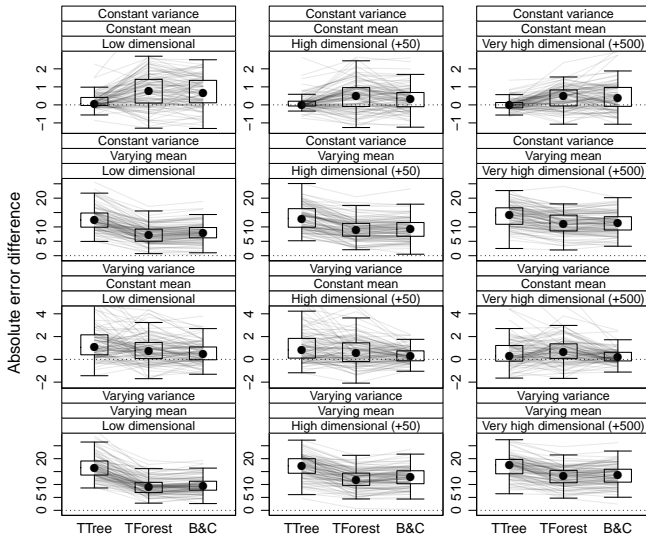

Low and High: 10% Quantile

$$Y \sim N(\mu(\mathbf{x}), \sigma^2(\mathbf{x}))$$

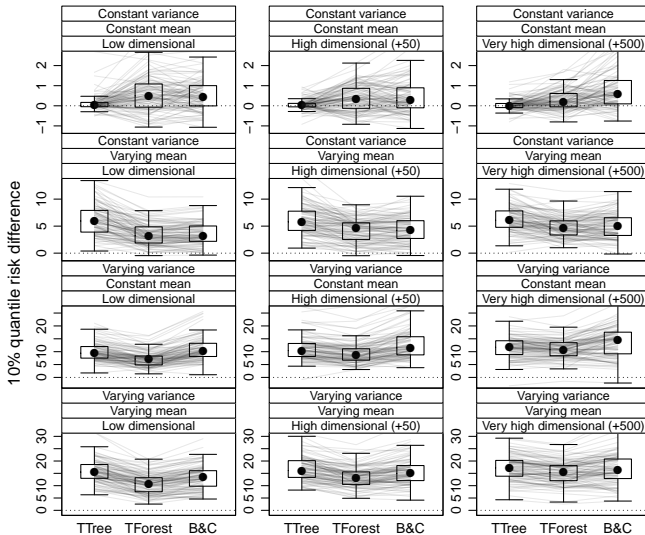

Low and High: 90% Quantile

$$Y \sim N(\mu(\mathbf{x}), \sigma^2(\mathbf{x}))$$

