

*The Dehornoy floor and the Markov  
Theorem without Stabilization*

*featuring work of Ito & Malyutin-Netsvetaev*

*joint work with Doug Lafountain & Hiroshi Matsuda*

*Banff, Feb. 16, 2012*

# *Braided block-strand (BBS) diagrams*

# *Braided block-strand (BBS) diagrams*

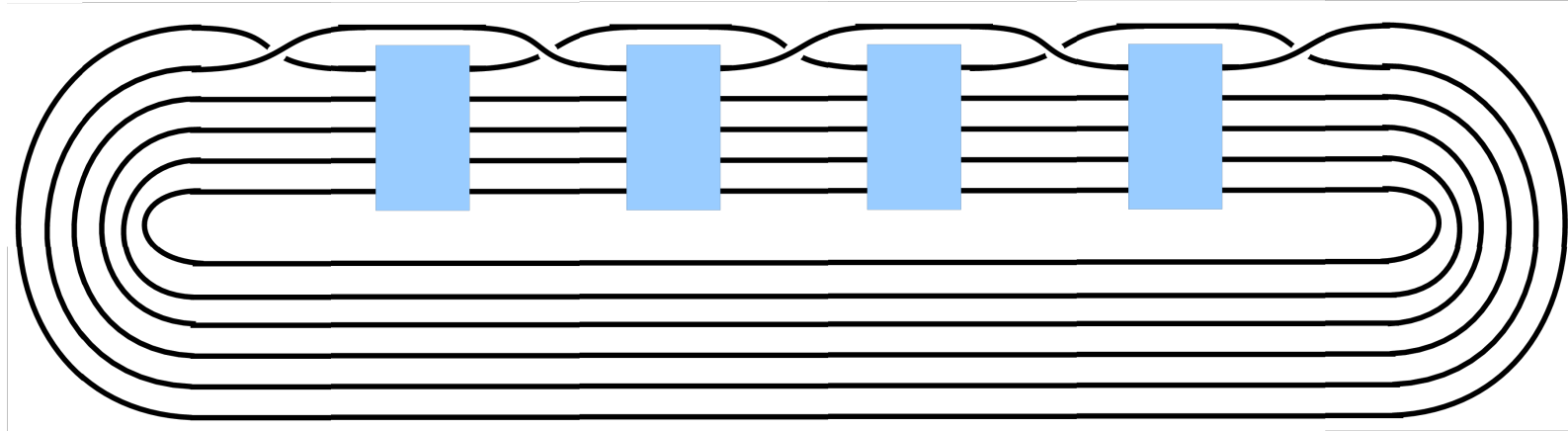

# *Braided block-strand (BBS) diagrams*

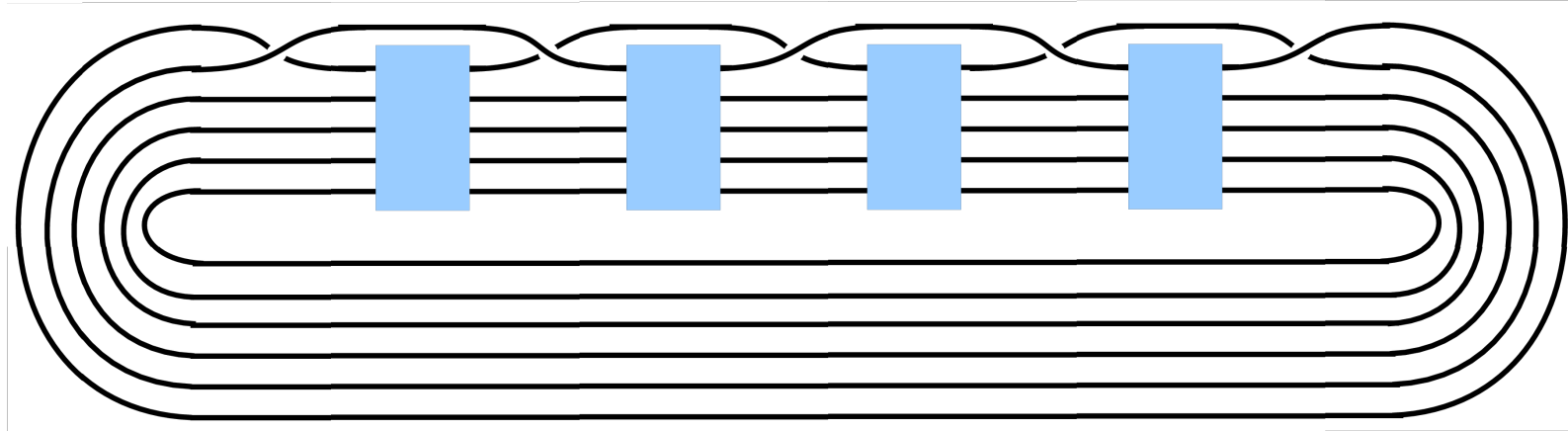

- We can talk about the braid index of a BBS.

# *Braided block-strand (BBS) diagrams*

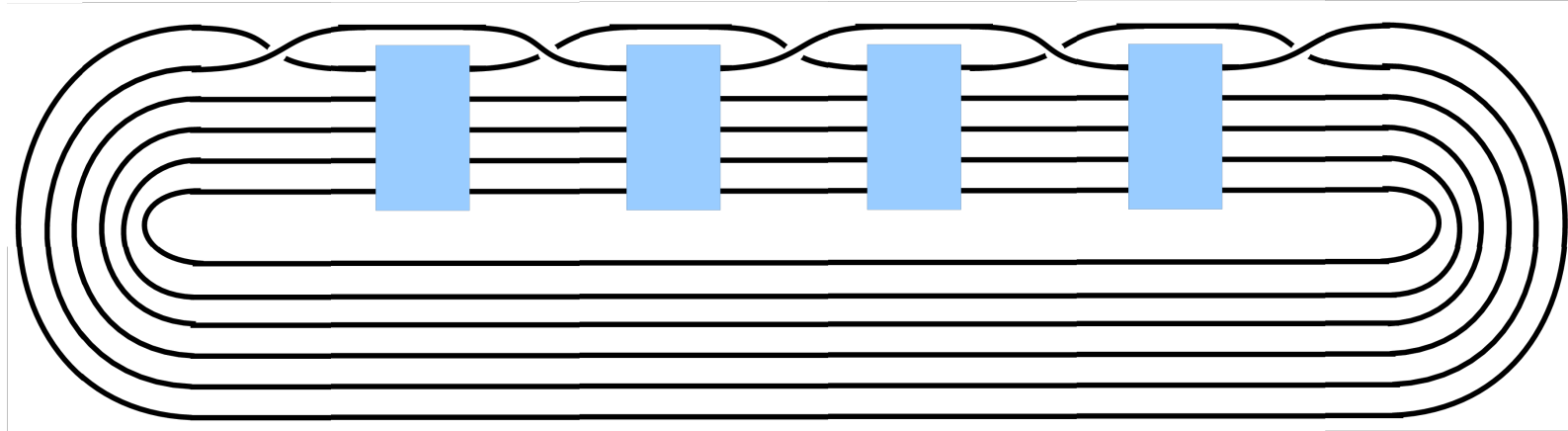

- We can talk about the braid index of a BBS.
- We can talk about closed braids which are carried by a BBS.

# *Braided block-strand (BBS) diagrams*

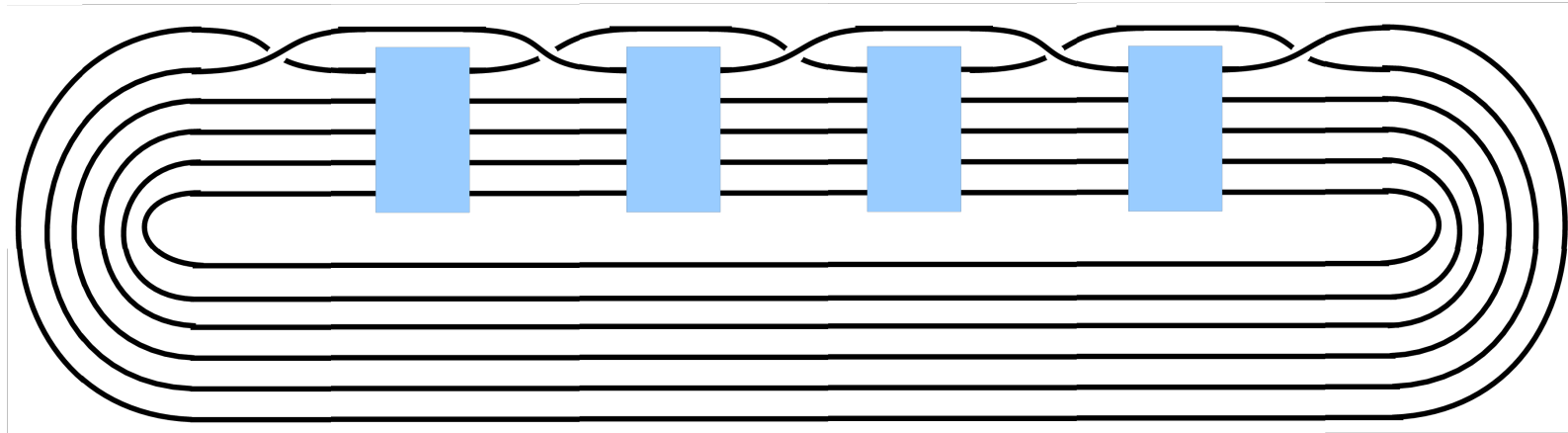

- We can talk about the braid index of a BBS.
- We can talk about closed braids which are carried by a BBS..
- We can talk about braid isotopies between two BBS.

# *Braided block-strand (BBS) diagrams*

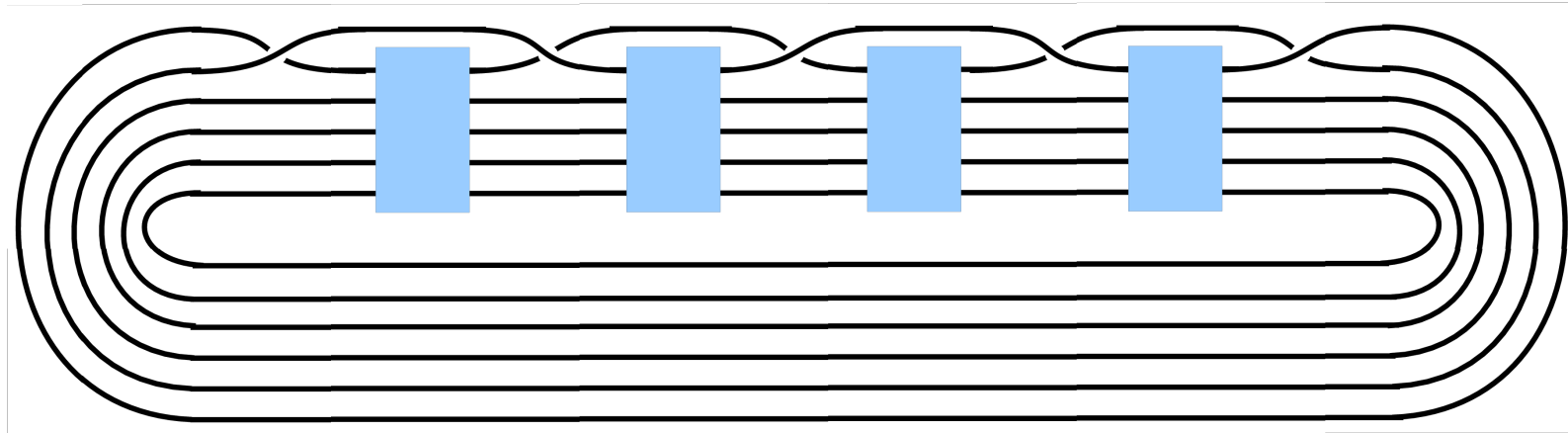

*Theorem- Let  $D$  be a BBS diagram of braid index  $n$ . Then there exists infinitely many closed  $n$ -braids that  $D$  does not carry.  
(Birman-M 2006)*

# *Some classical examples of BBS*



# *Some classical examples of BBS*

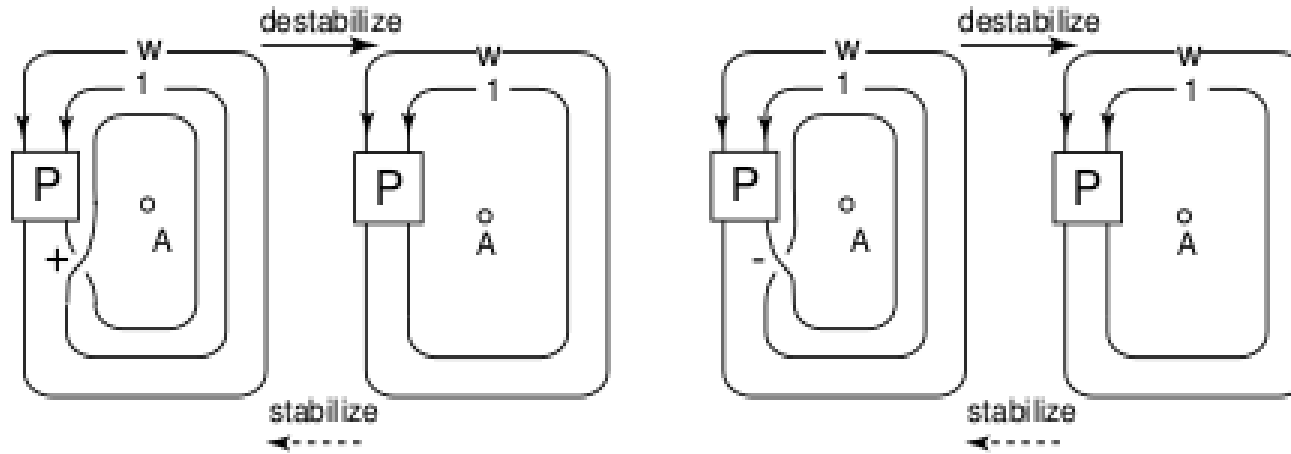

# Some classical examples of BBS

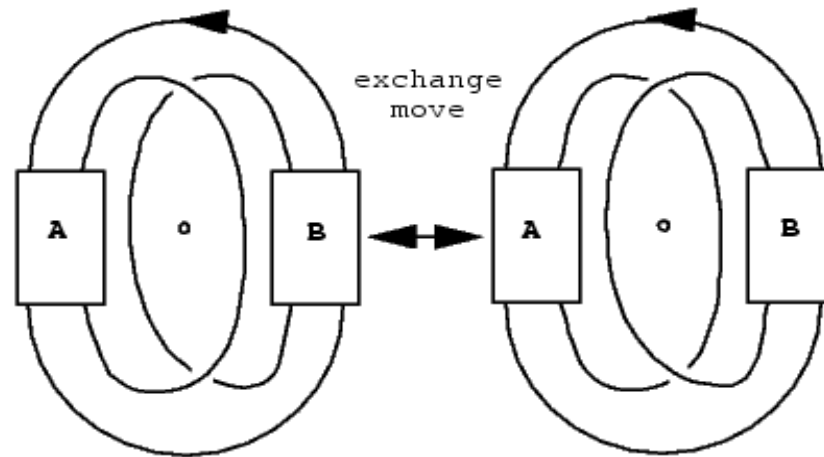
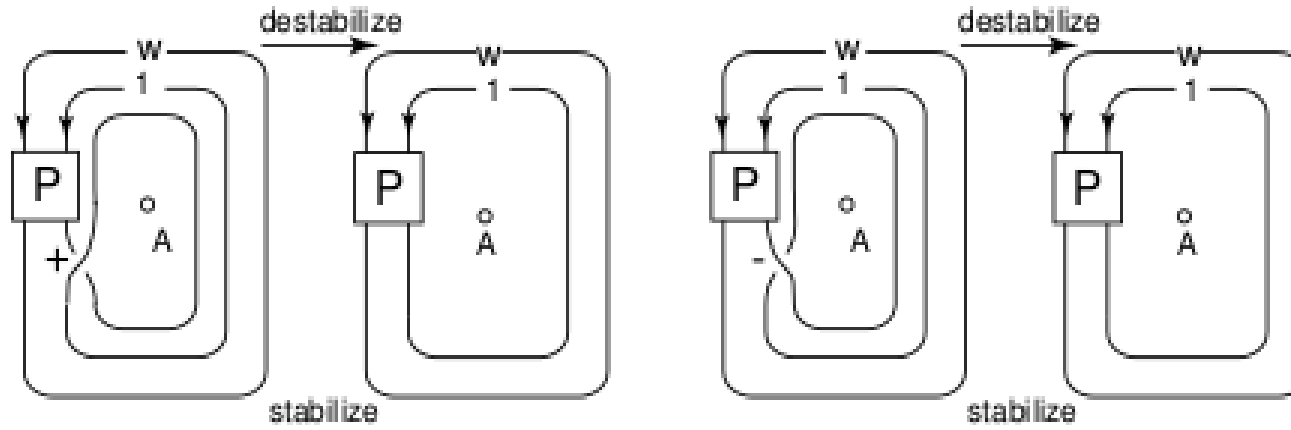

# Some classical examples of BBS

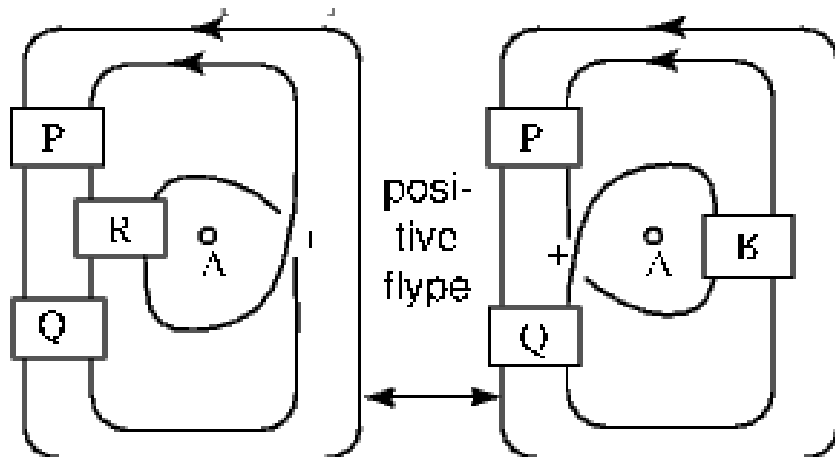
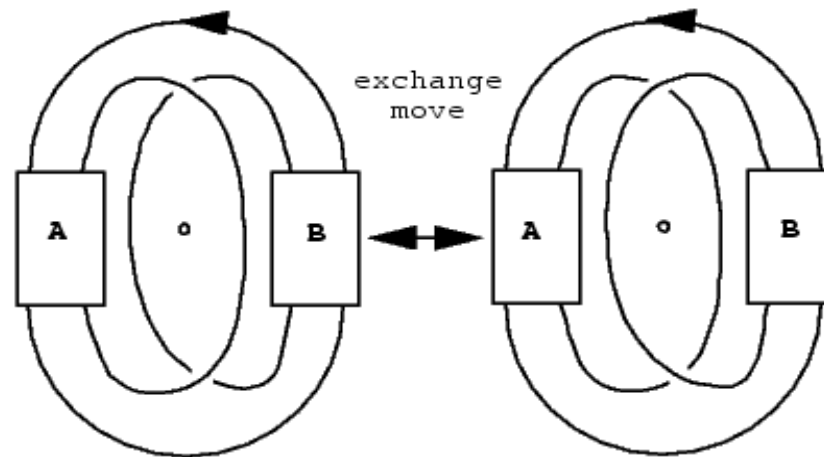
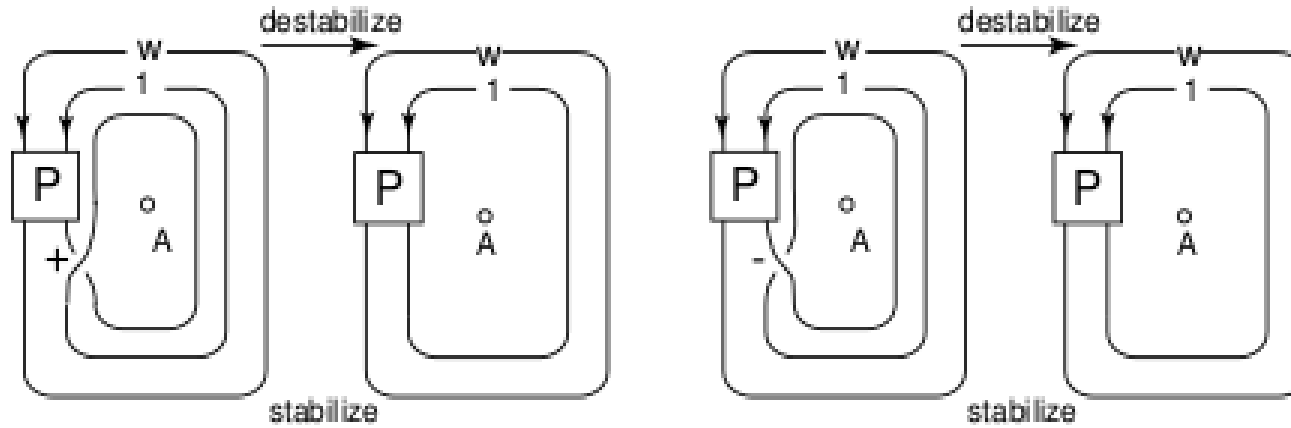

# Some classical examples of BBS

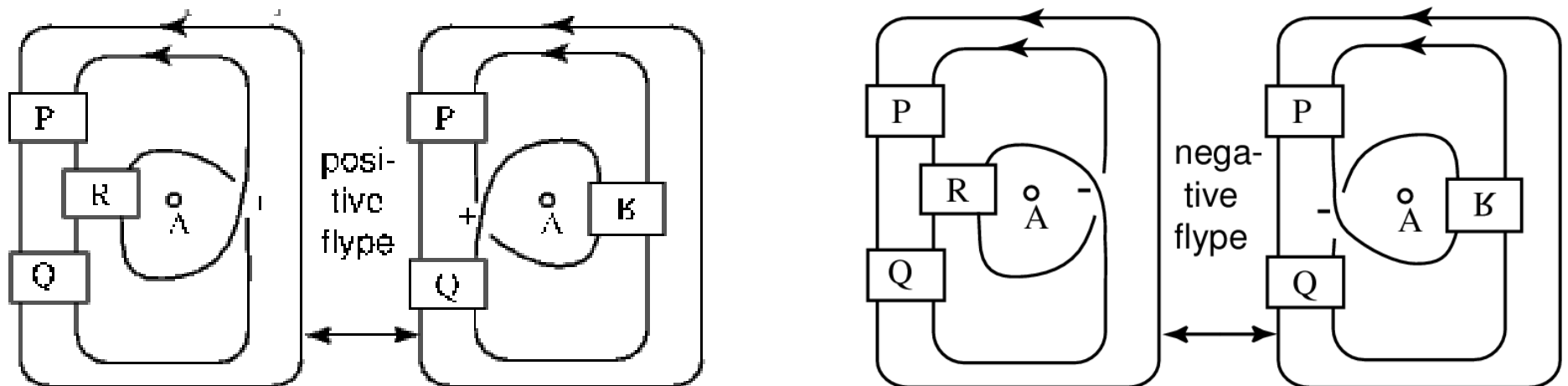
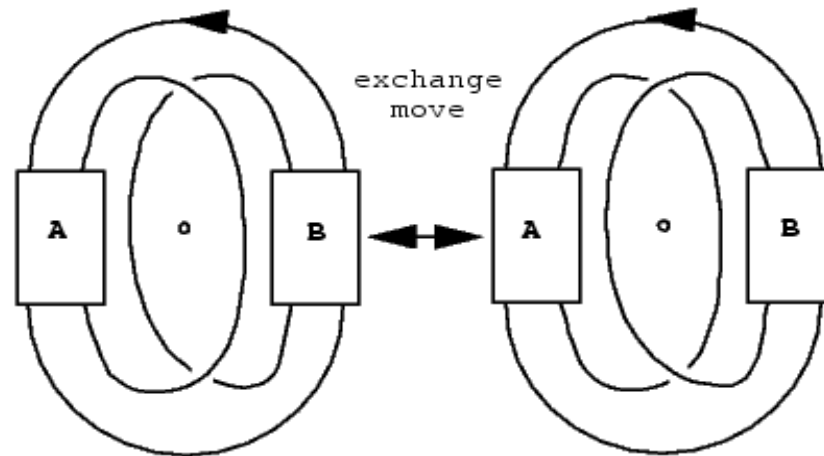
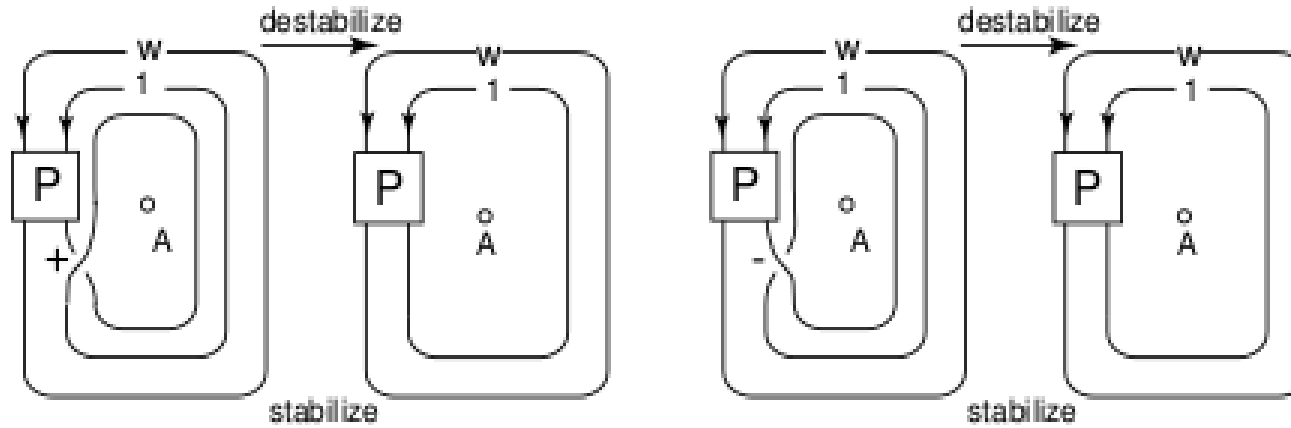

Connection of *BBS* diagrams with  
Dehornoy ordering in the braid  
group  $B_n$

# Connection of *BBS* diagrams with Dehornoy ordering in the braid group $B_n$

- (Dehornoy Floor)—The Dehornoy floor  $[\beta]_D$  of an  $n$ -braid  $\beta$  is a non-negative integer defined by

$$[\beta]_D = \min\{m \in \mathbb{Z}_{\geq 0} \mid \Delta^{-2m-2} <_D \beta <_D \Delta^{2m+2}\}$$

where  $\Delta = (\sigma_1\sigma_2 \cdots \sigma_{n-1})(\sigma_1\sigma_2 \cdots \sigma_{n-2}) \cdots (\sigma_1\sigma_2)(\sigma_1)$   
is the Garside fundamental  $n$ -braid.

# Connection of *BBS* diagrams with Dehornoy ordering in the braid group $B_n$

- (Dehornoy Floor)—The Dehornoy floor  $[\beta]_D$  of an  $n$ -braid  $\beta$  is a non-negative integer defined by

$$[\beta]_D = \min\{m \in \mathbb{Z}_{\geq 0} \mid \Delta^{-2m-2} <_D \beta <_D \Delta^{2m+2}\}$$

where  $\Delta = (\sigma_1\sigma_2 \cdots \sigma_{n-1})(\sigma_1\sigma_2 \cdots \sigma_{n-2}) \cdots (\sigma_1\sigma_2)(\sigma_1)$   
is the Garside fundamental  $n$ -braid.

- The Dehornoy floor is not a conjugacy invariant,  
but ...

# Connection of *BBS* diagrams with Dehornoy ordering in the braid group $B_n$

- (Dehornoy Floor)—The Dehornoy floor  $[\beta]_D$  of an  $n$ -braid  $\beta$  is a non-negative integer defined by

$$[\beta]_D = \min\{m \in \mathbb{Z}_{\geq 0} \mid \Delta^{-2m-2} <_D \beta <_D \Delta^{2m+2}\}$$

where  $\Delta = (\sigma_1\sigma_2 \cdots \sigma_{n-1})(\sigma_1\sigma_2 \cdots \sigma_{n-2}) \cdots (\sigma_1\sigma_2)(\sigma_1)$   
is the Garside fundamental  $n$ -braid.

- The Dehornoy floor is not a conjugacy invariant,  
but ...
- If a braid  $\beta$  is conjugate to a braid  $\alpha$  which admits  
a word representative with  $s(> 0)$  occurrences of  
 $\sigma_1$  and  $k(> 0)$  occurrences of  $\sigma_1^{-1}$  then  $[\beta]_D <$   
 $\max\{s, k\}$ . (T. Ito, A. Maljutin, N. Nesvetaev)



# Connection of *BBS* diagrams with Dehornoy ordering in the braid group $B_n$

- (Dehornoy Floor)—The Dehornoy floor  $[\beta]_D$  of an  $n$ -braid  $\beta$  is a non-negative integer defined by

$$[\beta]_D = \min\{m \in \mathbb{Z}_{\geq 0} \mid \Delta^{-2m-2} <_D \beta <_D \Delta^{2m+2}\}$$

where  $\Delta = (\sigma_1\sigma_2 \cdots \sigma_{n-1})(\sigma_1\sigma_2 \cdots \sigma_{n-2}) \cdots (\sigma_1\sigma_2)(\sigma_1)$  is the Garside fundamental  $n$ -braid.

- The Dehornoy floor is not a conjugacy invariant, but ...
- If a braid  $\beta$  is conjugate to a braid  $\alpha$  which admits a word representative with  $s(> 0)$  occurrences of  $\sigma_1$  and  $k(> 0)$  occurrences of  $\sigma_1^{-1}$  then  $[\beta]_D < \max\{s, k\}$ . (T. Ito, A. Maljutin, N. Nesvetaev)
- For each BBS diagram  $\mathcal{D}$ , there exists an integer  $m(\mathcal{D})$  such that if  $[\beta]_D \geq m(\mathcal{D})$  then  $\beta$  is not carried by  $\mathcal{D}$  then . (T. Ito)

Back to BBS diagrams. Their initial use comes from the MTWS.

**Theorem 2 (The Markov Theorem without Stabilization, Birman-M 2003)** *Given a pair of positive integers  $(n^b, n^a)$ , where  $n^b \geq n^a > 1$ , there exists a finite collection of associated templates  $\{(\mathcal{D}_1^b, \mathcal{D}_1^a), \dots, (\mathcal{D}_l^b, \mathcal{D}_l^a)\}$  such that for any oriented link type  $\mathcal{L}$  having braid index  $b(\mathcal{X}) = n^a$  and any closed braid representatives  $L_1, L_2 \in \mathcal{L}$  with  $b(L_1) = n_b$  and  $b(L_2) = n_a$  there exists  $L'_1, L'_2 \in \mathcal{L}$  with  $b(L'_1) = n^{b'}$ ,  $n^b \geq n^{b'}$ , and  $b(L'_2) = n^a$  such that:*

- i)  $L'_1$  is obtained from  $L_1$  via destabilizations and exchange moves; and,  $L'_2$  is obtained from  $X_1$  via exchange moves, i.e. exchange equivalent.*
- ii)  $L'_1 \text{ \& } L'_2$  are carried by some  $\mathcal{D}_j^b \text{ \& } \mathcal{D}_j^a$ , respectively. Moreover, the braiding assignment  $L'_1$  imposes on the blocks of  $\mathcal{D}_j^b$  coincides with the braiding assignment  $L'_2$  imposes on the corresponding blocks of  $\mathcal{D}_j^a$ .*

(2003) Malyutin and Netsvetaev establish further connections between the Dehornoy floor and the MTWS

(2003) Malyutin and Netsvetsev establish further connections between the Dehornoy floor and the MTWS

**Theorem 1** *Let  $\beta$  be an  $n$ -braid.*

1. *If  $\hat{\beta}$  admits a destabilization or an exchange move then  $[\beta]_D = 0$ .*
2. *If  $\hat{\beta}$  admits a fltype then  $[\beta]_D \leq 1$ .*

**(2003) Malyutin and Netsvetsev establish further connections between the Dehornoy floor and the MTWS**

**Theorem 1** *Let  $\beta$  be an  $n$ -braid.*

1. *If  $\hat{\beta}$  admits a destabilization or an exchange move then  $[\beta]_D = 0$ .*
2. *If  $\hat{\beta}$  admits a flype then  $[\beta]_D \leq 1$ .*
3. *if  $\hat{\beta}$  is a split link then  $[\beta]_D = 0$ .*

**(2003) Malyutin and Netsvetsev establish further connections between the Dehornoy floor and the MTWS**

**Theorem 1** *Let  $\beta$  be an  $n$ -braid.*

1. *If  $\hat{\beta}$  admits a destabilization or an exchange move then  $[\beta]_D = 0$ .*
2. *If  $\hat{\beta}$  admits a flype then  $[\beta]_D \leq 1$ .*
3. *if  $\hat{\beta}$  is a split link then  $[\beta]_D = 0$ .*
4. *For each  $n$ , there exists a positive integer  $r(n)$  with the following property: For  $\alpha, \beta \in B_n$ , if  $[\alpha]_D \geq r(n)$  then the closed braids  $\hat{\alpha}$  and  $\hat{\beta}$  represent the same oriented link if and only if  $\alpha$  and  $\beta$  are conjugate.*

(2003) Malyutin and Netsvetsev establish further connections between the Dehornoy floor and the MTWS

**Theorem 1** *Let  $\beta$  be an  $n$ -braid.*

1. *If  $\hat{\beta}$  admits a destabilization or an exchange move then  $[\beta]_D = 0$ .*
2. *If  $\hat{\beta}$  admits a flype then  $[\beta]_D \leq 1$ .*
3. *if  $\hat{\beta}$  is a split link then  $[\beta]_D = 0$ .*
4. *For each  $n$ , there exists a positive integer  $r(n)$  with the following property: For  $\alpha, \beta \in B_n$ , if  $[\alpha]_D \geq r(n)$  then the closed braids  $\hat{\alpha}$  and  $\hat{\beta}$  represent the same oriented link if and only if  $\alpha$  and  $\beta$  are conjugate.*
5. *The minimal value of  $r(3)$  is 2.*

How well behaved is the Dehornoy floor with changes in braid index?



How well behaved is the Dehornoy floor with changes in braid index?

We have an example of Malyutin & Netsvetaev

How well behaved is the Dehornoy floor with changes in braid index?

We have an example of Malyutin & Netsvetaev

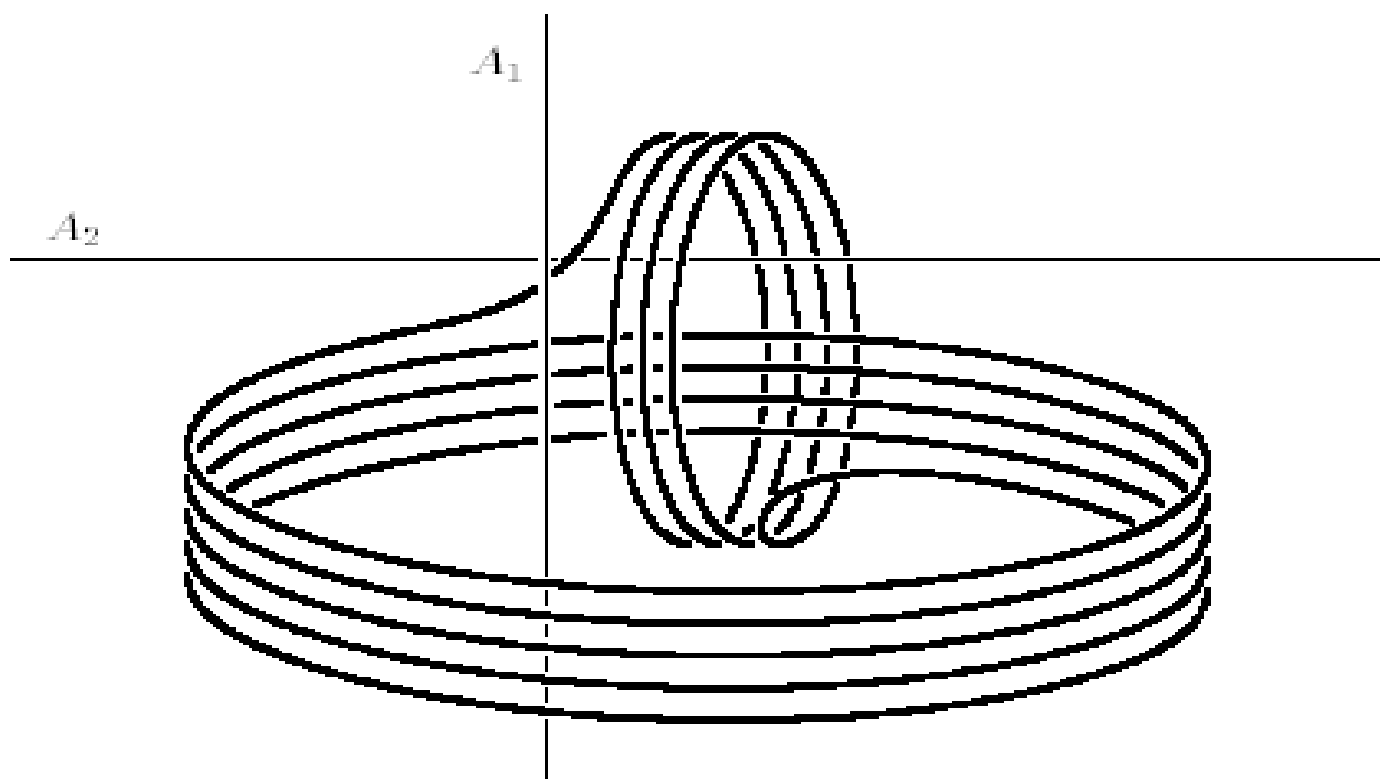

*Dehornoy's Ordering on the braid group and braid moves, St. Petersburg Math. J. 2004. Figure 2.*

How well behaved is the Dehornoy floor with changes in braid index?

We have an example of Malyutin & Netsvetaev

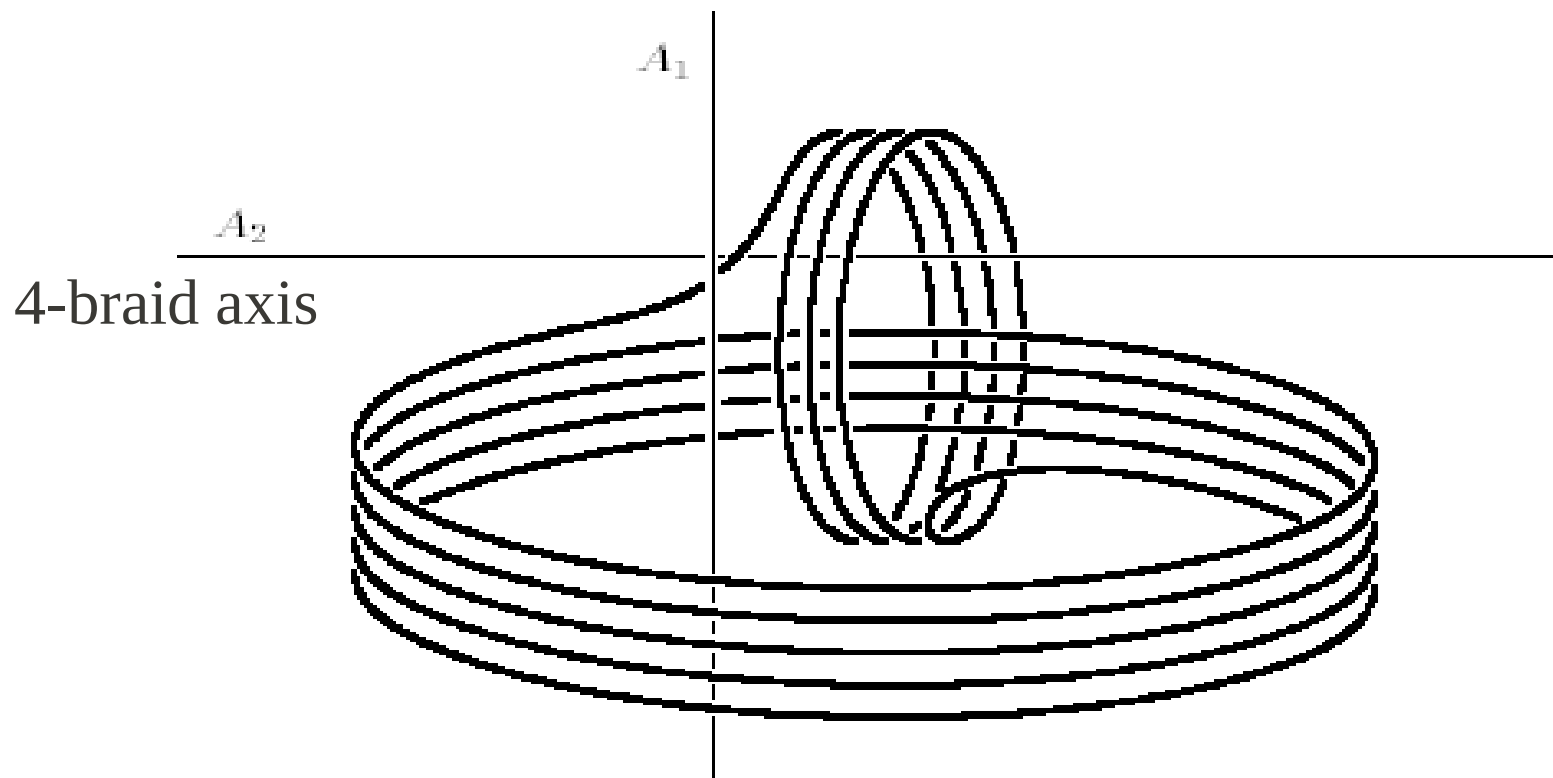

*Dehornoy's Ordering on the braid group and braid moves, St. Petersburg Math. J. 2004. Figure 2.*

How well behaved is the Dehornoy floor with changes in braid index?

We have an example of Malyutin & Netsvetaev

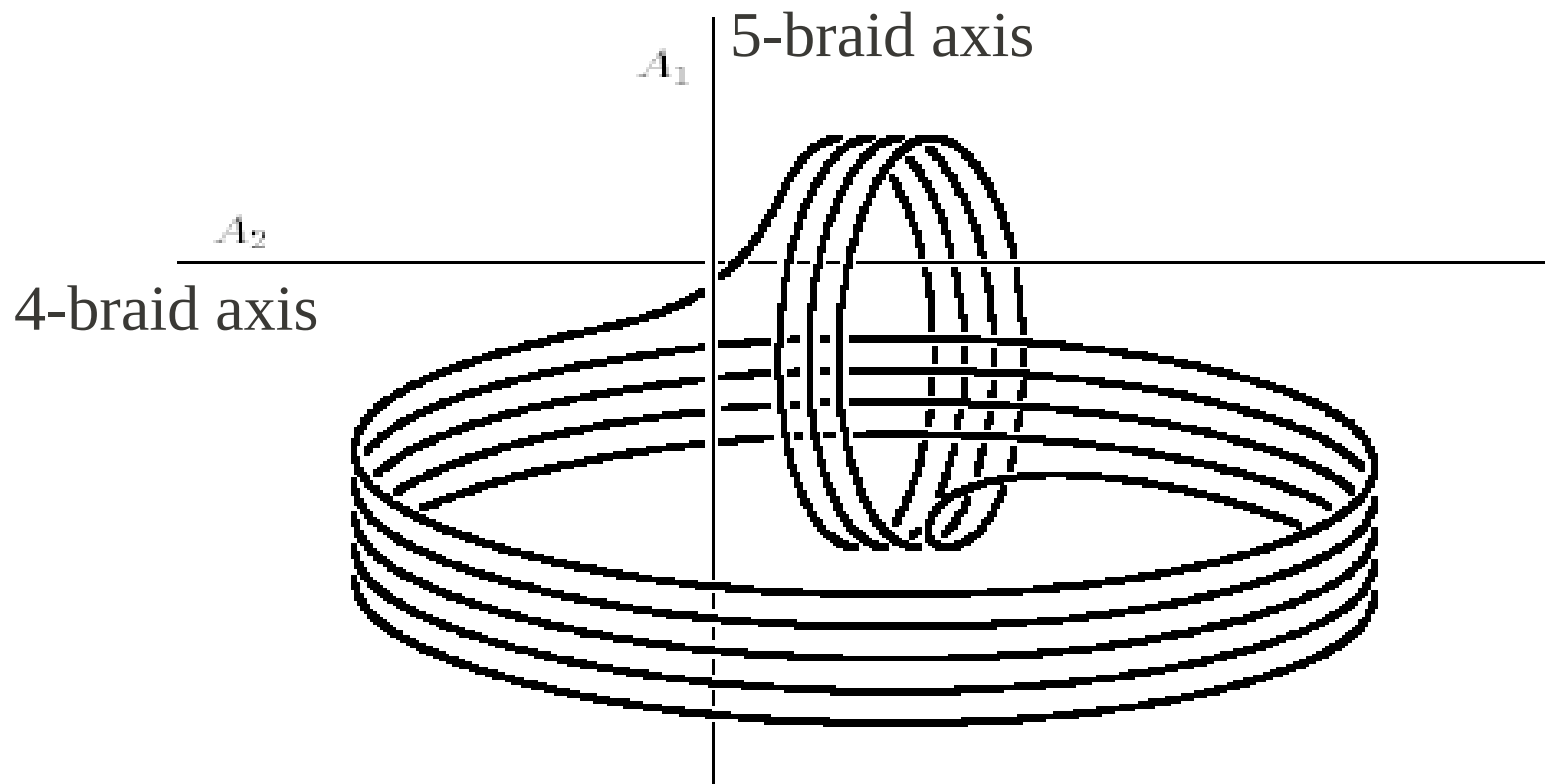

How well behaved is the Dehornoy floor with changes in braid index?

We have an example of Malyutin & Netsvetaev

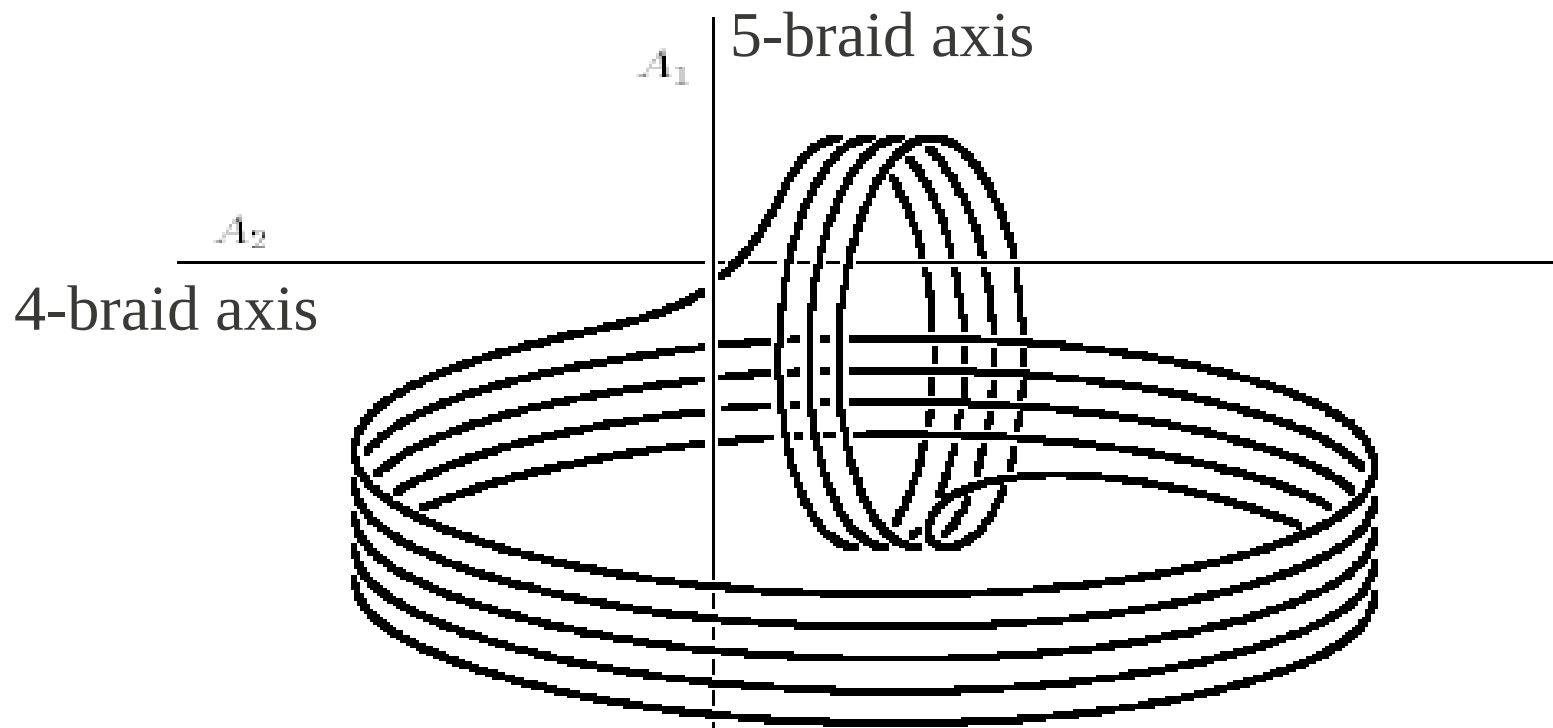

5-braid does not admit a destabilization, exchange move or flype

*Dehornoy's Ordering on the braid group and braid moves*, St. Petersburg Math. J. 2004. Figure 2.

The Malyutin-Netsvetaev example is part of a larger class of examples that was noticed by H. Matsuda.

The Malyutin-Netsvetaev example is part of a larger class of examples that was noticed by H. Matsuda. Let's rethink the braid preserving flype.

The Malyutin-Netsvetaev example is part of a larger class of examples that was noticed by H. Matsuda.

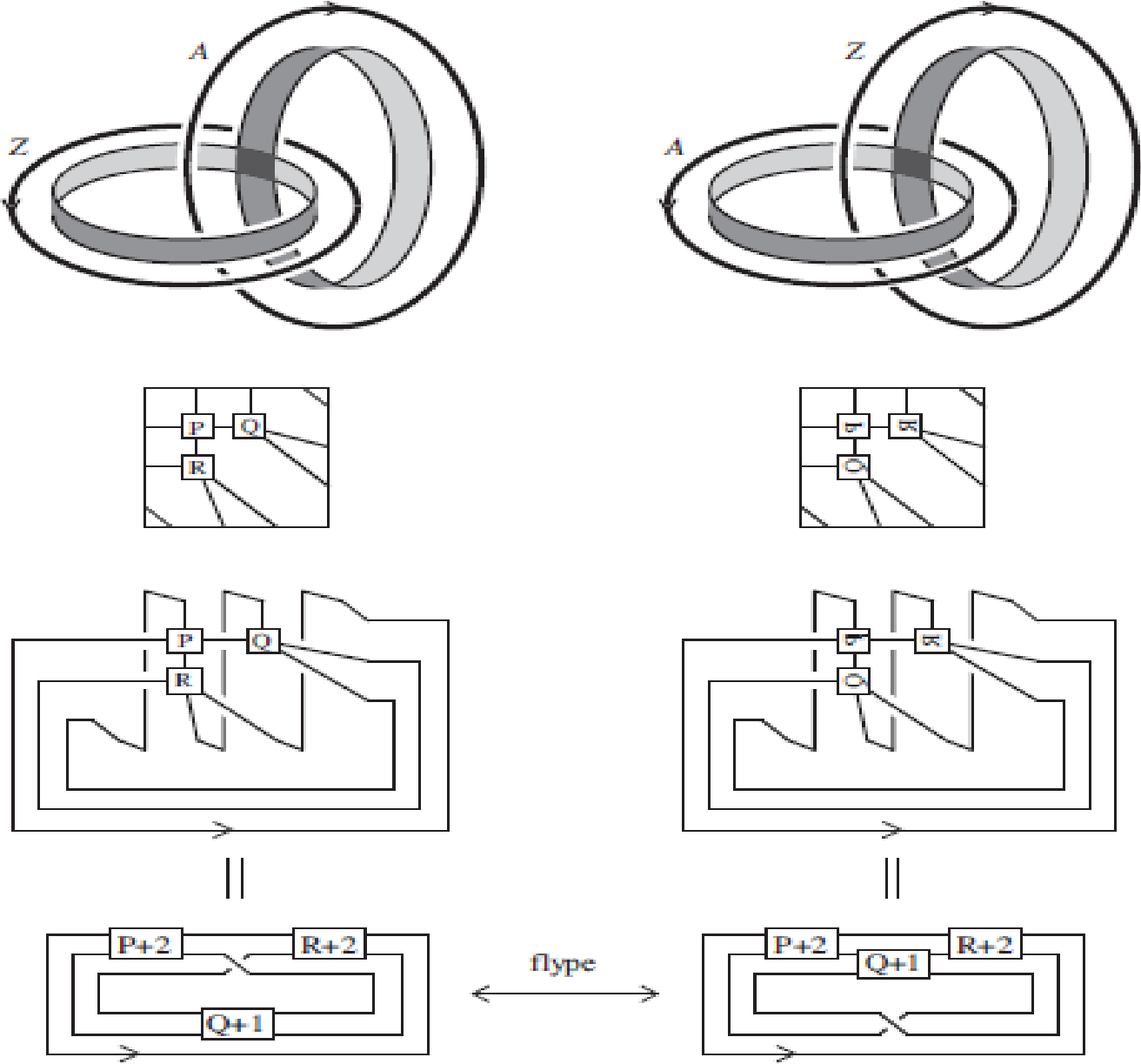

Figure by H. Matsuda.



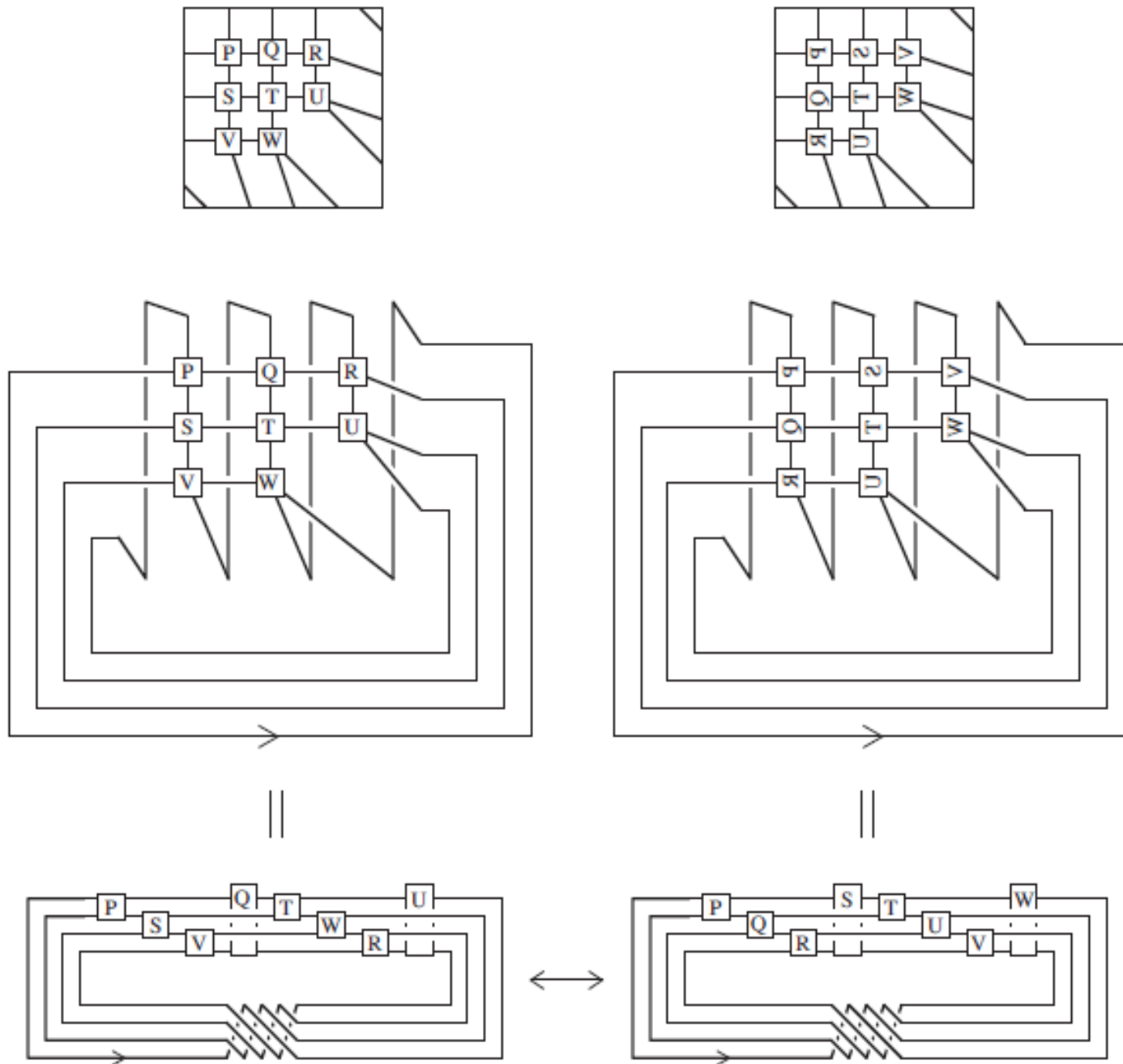

Figure by H. Matsuda.

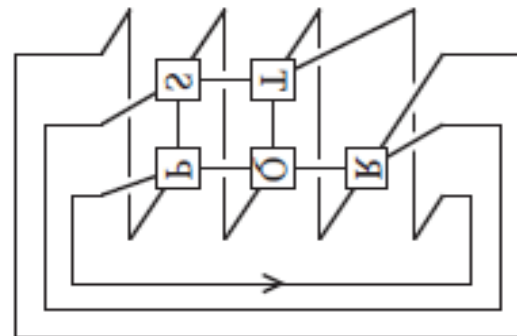
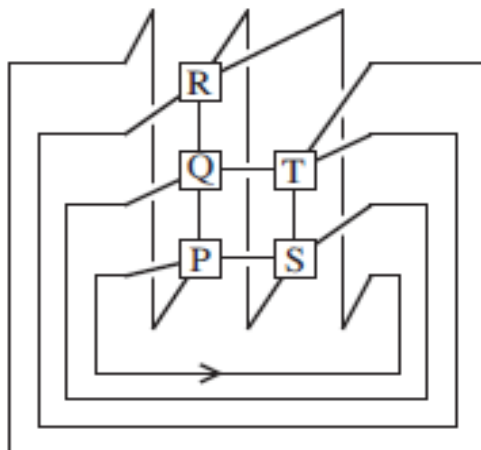
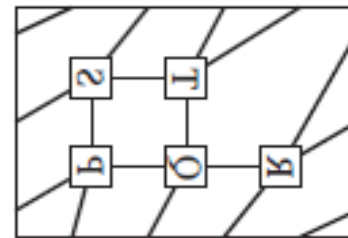
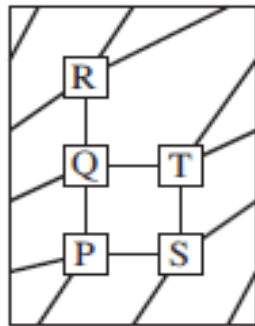
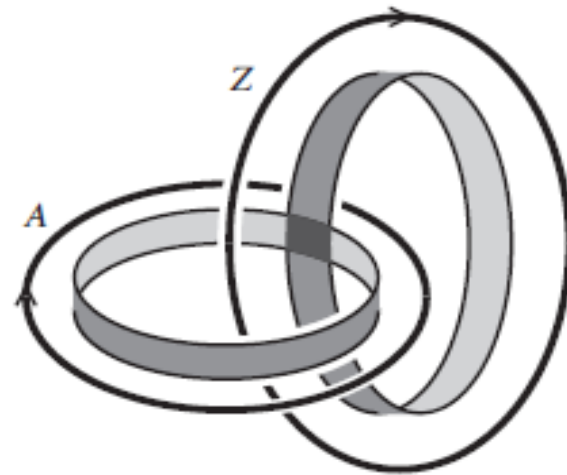
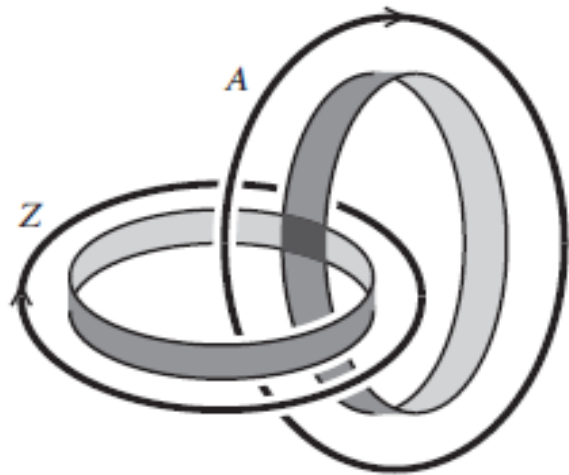

Figure by H. Matsuda.

Juxtaposing conjectures concerning the  
behavior of algebraic length and the  
Dehornoy floor under  
destabilization/destabilization.

**Juxtaposing conjectures concerning the  
behavior of algebraic length and the  
Dehornoy floor under  
destabilization/destabilization.**

- Let  $\hat{\beta}$  be a closed braid of minimal index,  $m$ .  
Let  $\hat{\beta}'$  be a closed  $n$ -braid representing the same  
oriented link. Then,  $|e(\hat{\beta}') - e(\hat{\beta})| \leq n - m$ . In  
particular, for  $m = n$  the algebraic length is a link  
invariant. (Strong Jones Conjecture.)

**Juxtaposing conjectures concerning the  
behavior of algebraic length and the  
Dehornoy floor under  
destabilization/destabilization.**

- Let  $\hat{\beta}$  be a closed braid of minimal index,  $m$ . Let  $\hat{\beta}'$  be a closed  $n$ -braid representing the same oriented link. Then,  $|e(\hat{\beta}') - e(\hat{\beta})| \leq n - m$ . In particular, for  $m = n$  the algebraic length is a link invariant. (Strong Jones Conjecture.)
- Over all closed braid representatives of a fixed knot, the maximal Dehornoy floor value is only realized by minimal index representatives.
- Given a knot  $K$ , there exists an integer  $N_K > 0$  such that for any closed  $n$ -braid  $\hat{\beta}$  representing  $K$ , if  $n \geq N_K$  then  $[\hat{\beta}]_D = 0$ .

**Juxtaposing conjectures concerning the  
behavior of algebraic length and the  
Dehornoy floor under  
destabilization/destabilization.**

- Let  $\hat{\beta}$  be a closed braid of minimal index,  $m$ . Let  $\hat{\beta}'$  be a closed  $n$ -braid representing the same oriented link. Then,  $|e(\hat{\beta}') - e(\hat{\beta})| \leq n - m$ . In particular, for  $m = n$  the algebraic length is a link invariant. (Strong Jones Conjecture.)
- Over all closed braid representatives of a fixed knot, the maximal Dehornoy floor value is only realized by minimal index representatives.
- Given a knot  $K$ , there exists an integer  $N_K > 0$  such that for any closed  $n$ -braid  $\hat{\beta}$  representing  $K$ , if  $n \geq N_K$  then  $[\hat{\beta}]_D = 0$ .

Iterated doubling pairs  
&  
Dual-Foliated Branched Surfaces

# Review of Exchangeable Braids

(work of J. Stallings, H. Morton & M. Rampichini)



# Review of Exchangeable Braids

(work of J. Stallings, H. Morton & M. Rampichini)

- $A \sqcup Z$  are exchangeable.  $A$  and  $Z$  are each braided with respect to each other, with braid index  $m$ . Thus, the pair of unknotted braid axes  $(A, Z)$  has associated braid fibrations  $(\{A(\theta)\}, \{Z(\phi)\})$ .

# Review of Exchangeable Braids

(work of J. Stallings, H. Morton & M. Rampichini)

- $A \sqcup Z$  are exchangeable.  $A$  and  $Z$  are each braided with respect to each other, with braid index  $m$ . Thus, the pair of unknotted braid axes  $(A, Z)$  has associated braid fibrations  $(\{A(\theta)\}, \{Z(\phi)\})$ .
- $A$  and  $Z$  are mutually braided. Each disc fiber  $A(\theta)$  has a singular foliation induced by the fibration  $\{Z(\phi)\}$ , consisting of  $m$  transverse intersections with  $Z$  and  $m - 1$  saddle singularities. We have a similar arrangement for  $Z(\phi)$  and  $\{A(\theta)\}$ .

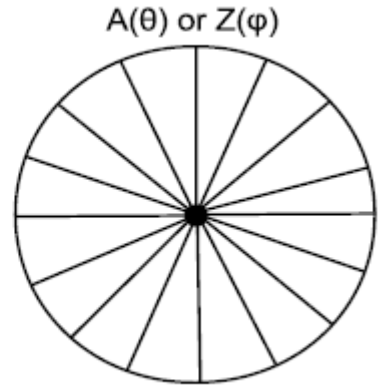
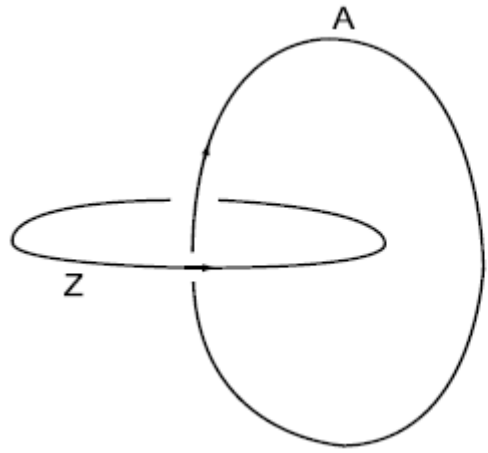

The Hopf link

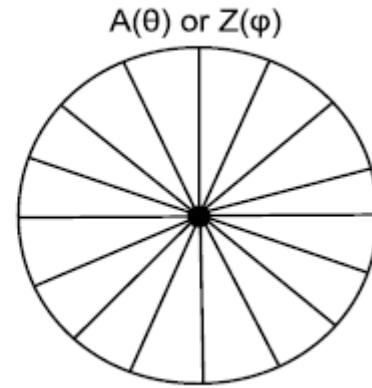
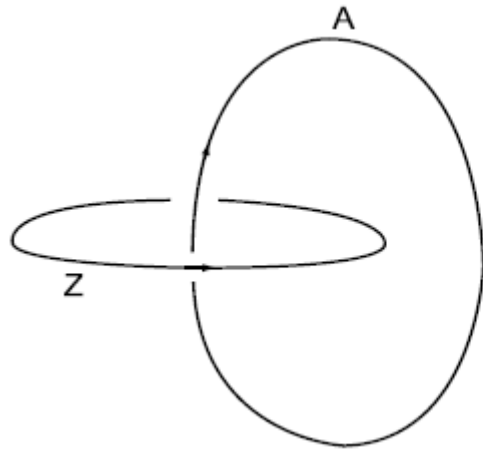

## The Hopf link

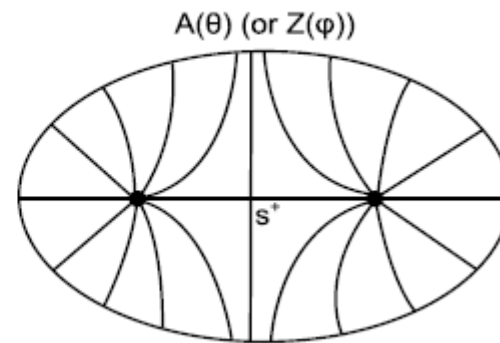
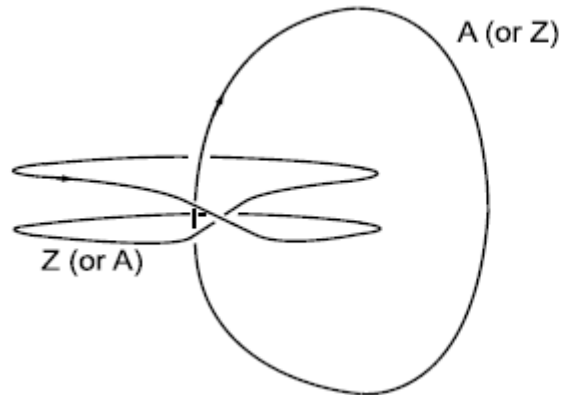

positive (1)-Morton double

# Iterated doubling pairs or Morton doubling pairs

# Iterated doubling pairs or Morton doubling pairs

- *Derived link:* The union of all the saddle singularities forms a link having unknotted components  $d_1, \dots, d_n$ , such that each  $d_i$  is braided with respect to  $\{A(\theta)\}$  and  $\{Z(\phi)\}$ .

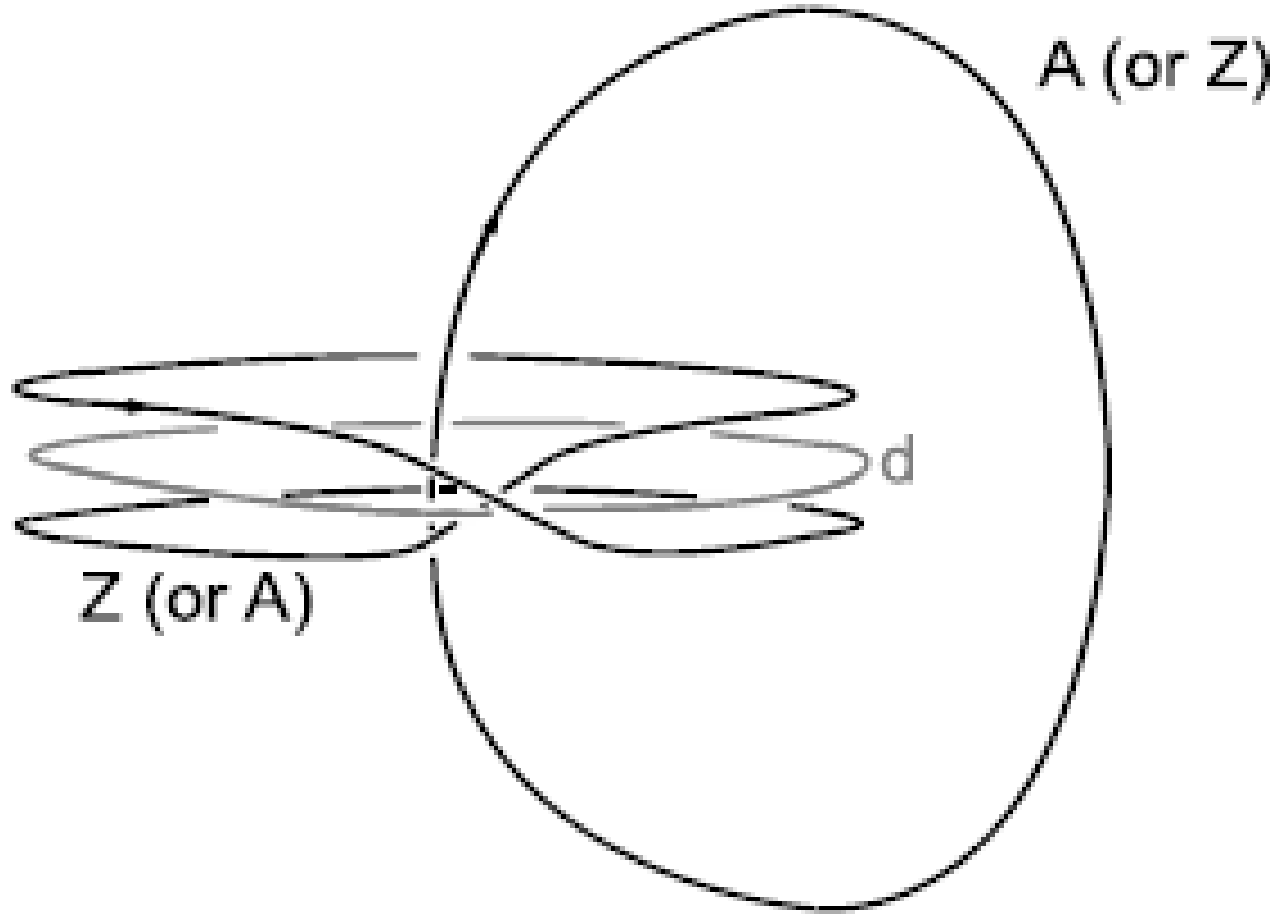

# Iterated doubling pairs or Morton doubling pairs

- *Derived link:* The union of all the saddle singularities forms a link having unknotted components  $d_1, \dots, d_n$ , such that each  $d_i$  is braided with respect to  $\{A(\theta)\}$  and  $\{Z(\phi)\}$ .
- The  $d_1, \dots, d_n$  can be ordered so that each  $d_i$  is a  $(\pm 1, 2)$ -cabling of  $d_i$ .



# Iterated doubling pairs or Morton doubling pairs

- *Derived link:* The union of all the saddle singularities forms a link having unknotted components  $d_1, \dots, d_n$ , such that each  $d_i$  is braided with respect to  $\{A(\theta)\}$  and  $\{Z(\phi)\}$ .
- The  $d_1, \dots, d_n$  can be ordered so that each  $d_i$  is a  $(\pm 1, 2)$ -cabling of  $d_i$ .
- Letting  $A := d_0$  and  $Z := d_{n+1}$ , then any pair  $(d_i, d_{i+1})$  is a Hopf link.

# Iterated doubling pairs or Morton doubling pairs

- *Derived link:* The union of all the saddle singularities forms a link having unknotted components  $d_1, \dots, d_n$ , such that each  $d_i$  is braided with respect to  $\{A(\theta)\}$  and  $\{Z(\phi)\}$ .
- The  $d_1, \dots, d_n$  can be ordered so that each  $d_i$  is a  $(\pm 1, 2)$ -cabling of  $d_i$ .
- Letting  $A := d_0$  and  $Z := d_{n+1}$ , then any pair  $(d_i, d_{i+1})$  is a Hopf link.
- Any pair  $(d_i, d_j)$  is itself an iterated doubling pair for  $i \neq j$ .

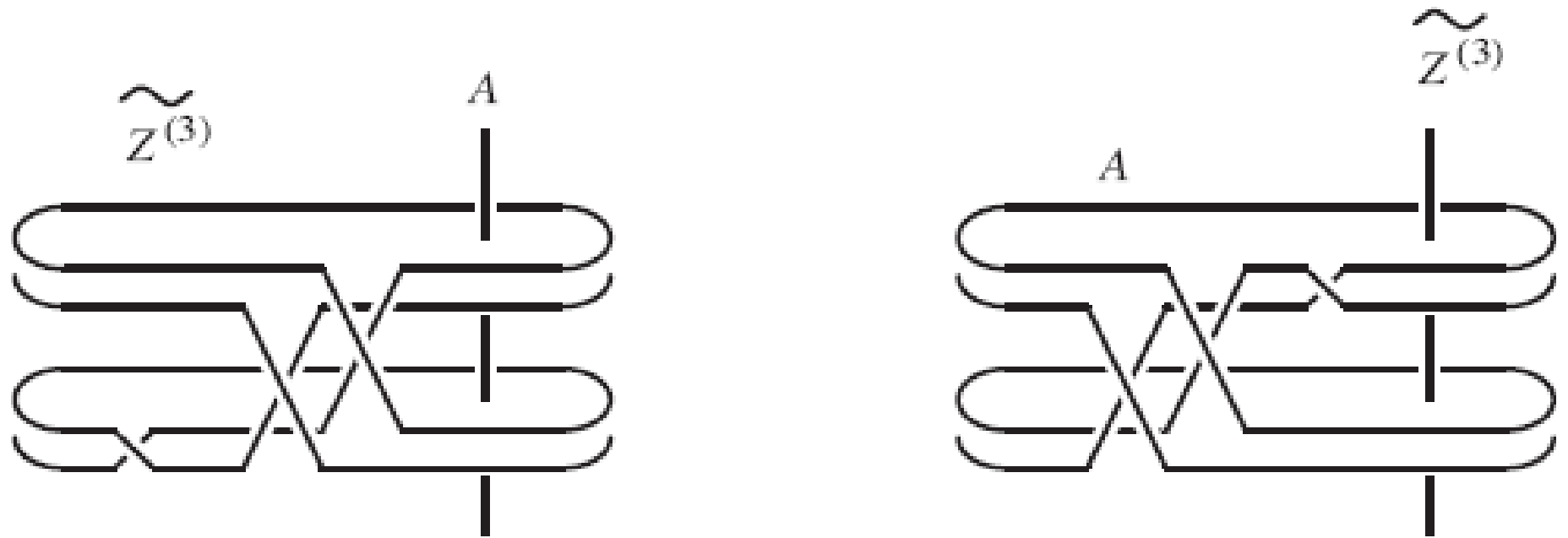

Two positive Morton doubling of Hopf link.

# Dual-Foliated Branched Surfaces

# Dual-Foliated Branched Surfaces

- $\mathcal{B}_{A,Z} \subset S^3 \setminus (A \cup Z)$  is a closed branched surface that is a union of tori  $T_0 \cup \cdots \cup T_n$  where  $(A, Z)$  is an iterated doubling pair.

# Dual-Foliated Branched Surfaces

- $\mathcal{B}_{A,Z} \subset S^3 \setminus (A \cup Z)$  is a closed branched surface that is a union of tori  $T_0 \cup \cdots \cup T_n$  where  $(A, Z)$  is an iterated doubling pair.
- Each torus  $T_i$  bounds an unknotted solid torus  $N_i$  such that  $N_i \subset N_{i+1}$  for  $0 \leq i < n$ ,

# Dual-Foliated Branched Surfaces

- $\mathcal{B}_{A,Z} \subset S^3 \setminus (A \cup Z)$  is a closed branched surface that is a union of tori  $T_0 \cup \cdots \cup T_n$  where  $(A, Z)$  is an iterated doubling pair.
- Each torus  $T_i$  bounds an unknotted solid torus  $N_i$  such that  $N_i \subset N_{i+1}$  for  $0 \leq i < n$ ,
- $T_i \cap T_{i+1}$  is an annular neighborhood of a  $(\pm 1, 2)$  knot on  $T_{i+1}$  for  $0 \leq i < n$ .

# Dual-Foliated Branched Surfaces

- $\mathcal{B}_{A,Z} \subset S^3 \setminus (A \cup Z)$  is a closed branched surface that is a union of tori  $T_0 \cup \cdots \cup T_n$  where  $(A, Z)$  is an iterated doubling pair.
- Each torus  $T_i$  bounds an unknotted solid torus  $N_i$  such that  $N_i \subset N_{i+1}$  for  $0 \leq i < n$ ,
- $T_i \cap T_{i+1}$  is an annular neighborhood of a  $(\pm 1, 2)$  knot on  $T_{i+1}$  for  $0 \leq i < n$ .
- The core of  $N_i$  is the derived component  $d_i(\subset N_i \setminus N_{i+1})$ .



# Dual-Foliated Branched Surfaces

- $\mathcal{B}_{A,Z} \subset S^3 \setminus (A \cup Z)$  is a closed branched surface that is a union of tori  $T_0 \cup \cdots \cup T_n$  where  $(A, Z)$  is an iterated doubling pair.
- Each torus  $T_i$  bounds an unknotted solid torus  $N_i$  such that  $N_i \subset N_{i+1}$  for  $0 \leq i < n$ ,
- $T_i \cap T_{i+1}$  is an annular neighborhood of a  $(\pm 1, 2)$  knot on  $T_{i+1}$  for  $0 \leq i < n$ .
- The core of  $N_i$  is the derived component  $d_i(\subset N_i \setminus N_{i+1})$ .
- $\mathcal{B}_{A,Z}$  is *dual foliated* by  $\{A(\theta)\}$  and  $\{Z(\phi)\}$ .

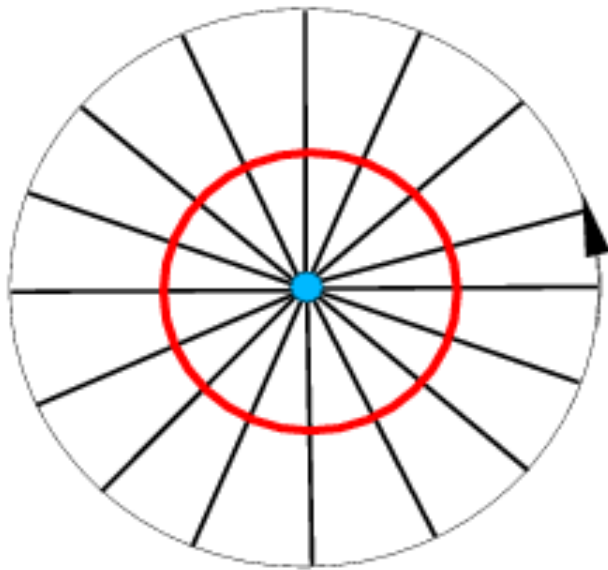

The suspension transverse train track (which is just a circle) for the Hopf link gives us the branched surface. In this case the branched surface corresponds to the peripheral torus for  $A$  and  $Z$ .

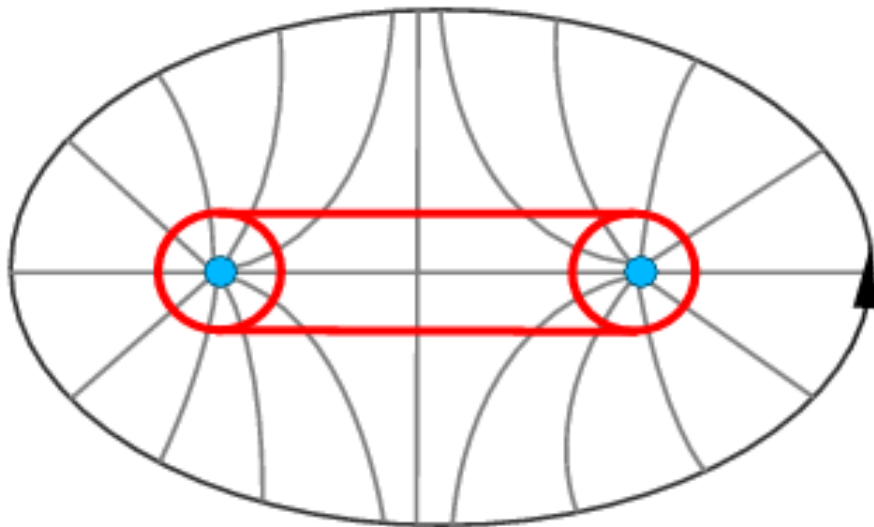

The suspension transverse train track for the (1)-Morton double gives us the branched surface. In this case the branched surface is the union of the peripheral tori for  $A$  and  $Z$ .

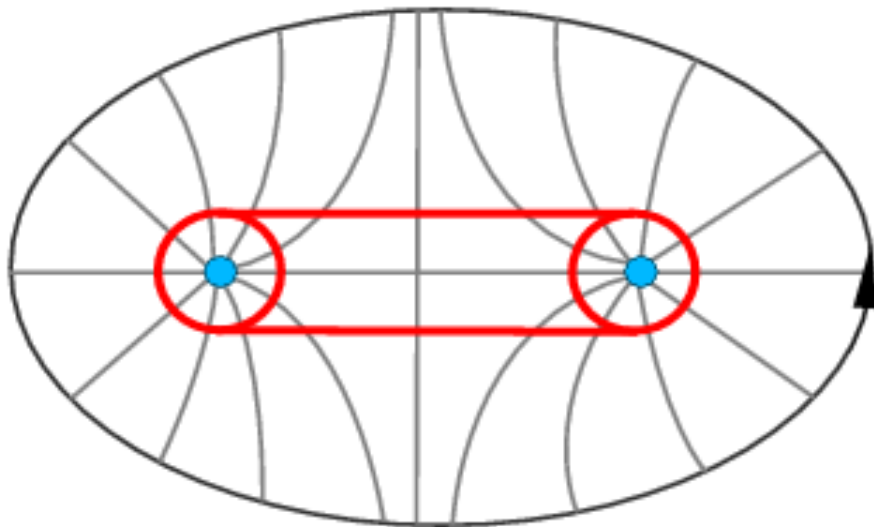
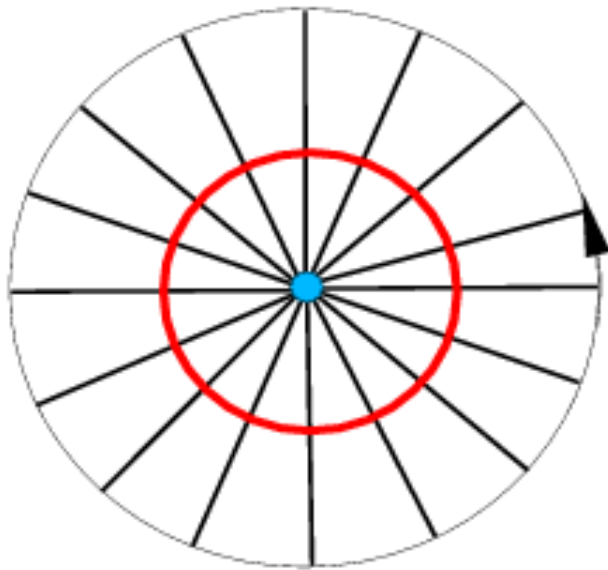

The dual foliation comes from the intersection of the branched surface with the two braid fibrations for the  $(A, Z)$  pair.

*Now consider the following configuration:*

- *$(A, Z)$  is an iterated doubling pair in  $S^3$ . (Recall  $A$  and  $Z$  are necessarily oriented.)*

*Now consider the following configuration:*

- *$(A, Z)$  is an iterated doubling pair in  $S^3$ . (Recall  $A$  and  $Z$  are necessarily oriented.)*
- *$L \subset S^3 \setminus (A \sqcup Z)$  is an oriented link.*

*Now consider the following configuration:*

- *$(A, Z)$  is an iterated doubling pair in  $S^3$ . (Recall  $A$  and  $Z$  are necessarily oriented.)*
- *$L \subset S^3 \setminus (A \sqcup Z)$  is an oriented link.*
- *$A$  is a braid axis for the oriented link  $L \sqcup Z$  and  $\{A(\theta)\}$  is a corresponding braid fibration. Thus,  $L$  is necessarily transverse to each  $A(\theta)$ .*

*Now consider the following configuration:*

- *$(A, Z)$  is an iterated doubling pair in  $S^3$ . (Recall  $A$  and  $Z$  are necessarily oriented.)*
- *$L \subset S^3 \setminus (A \sqcup Z)$  is an oriented link.*
- *$A$  is a braid axis for the oriented link  $L \sqcup Z$  and  $\{A(\theta)\}$  is a corresponding braid fibration. Thus,  $L$  is necessarily transverse to each  $A(\theta)$ .*
- *Similarly,  $Z$  is a braid axis for the oriented link  $A \sqcup L$  and  $\{Z(\phi)\}$  is a corresponding braid fibration. Thus,  $L$  is necessarily transverse to each  $Z(\phi)$ .*

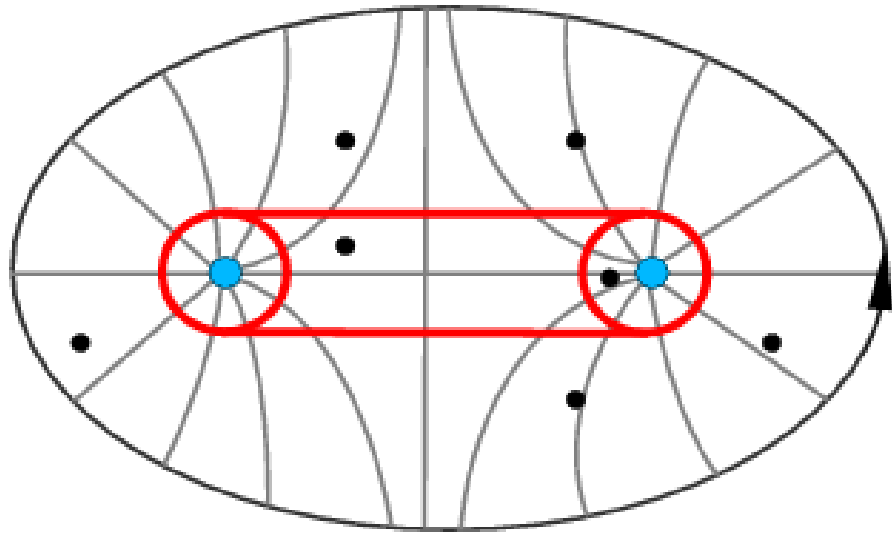
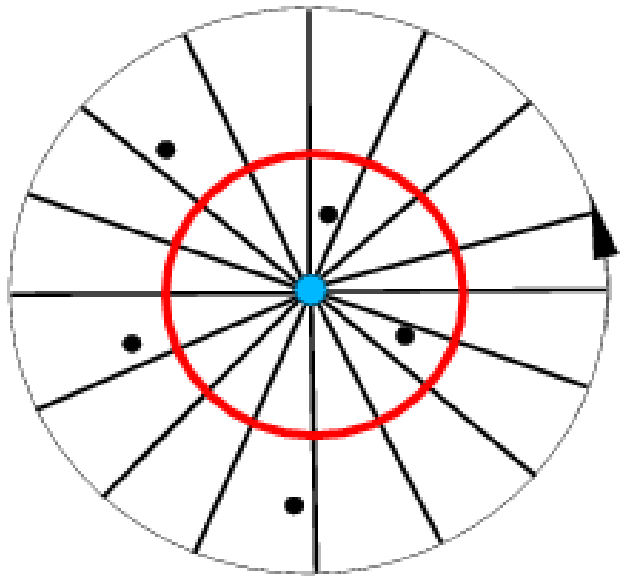

The black dots where the link  $L$  is intersecting the foliated disc fibers. As we push forward in the braid fibration we will see these dots move around in the disc fiber always positively transverse to the foliation of the fiber.

We can use the leaves of the foliation to project the link  $L$  onto the train track and, thus, the branched surface.



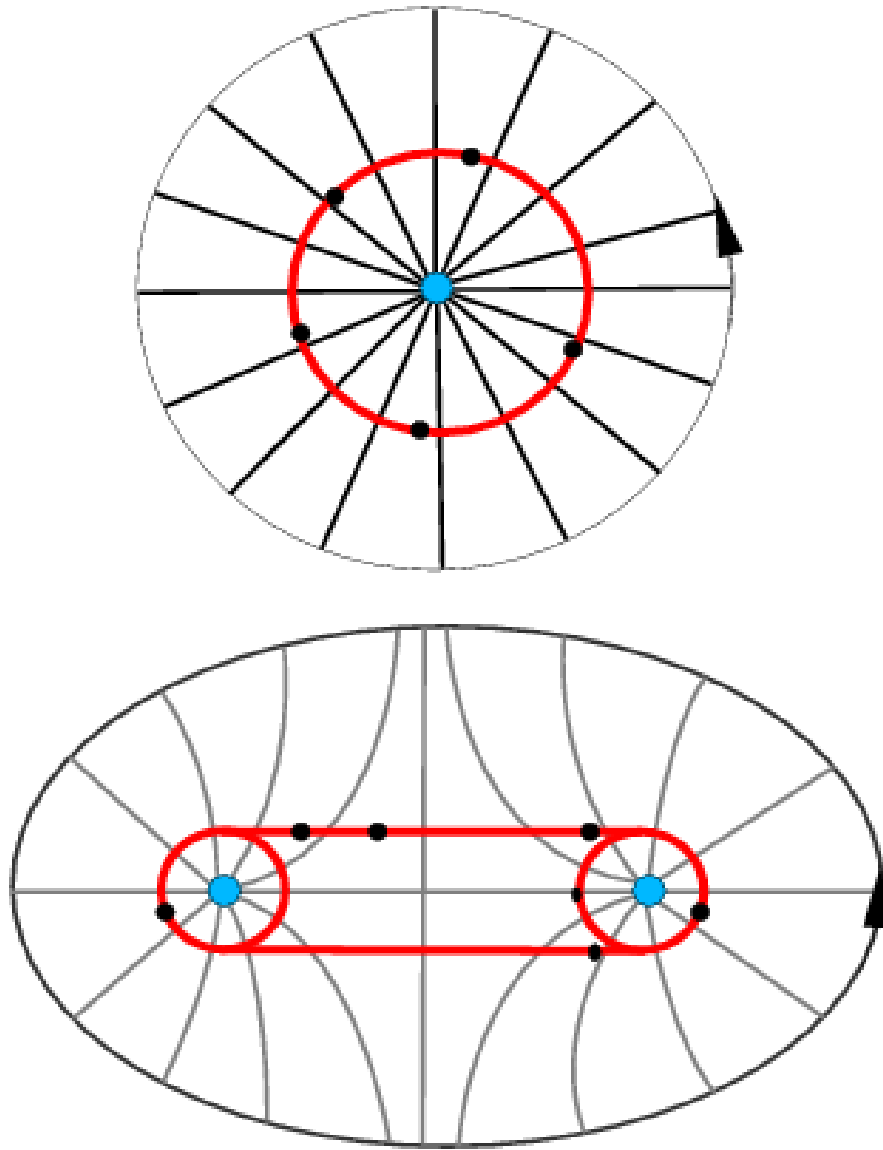

In the cyclic movie that runs as we move forward in the fibrations associated with either  $A$  or  $Z$  will see the black dots of  $L$  race around the oriented train track in the positive direction. A crossing of the projection onto the branched surface occurs whenever one dot passes other.

# Oriented links carried by dual-foliated branched surfaces

## Oriented links carried by dual-foliated branched surfaces

- $\mathcal{B}_{A,Z} \subset S^3 \setminus (A \cup Z)$  is a dual-foliated branched surface associated to an iterated double pair  $(A, Z)$ .

## Oriented links carried by dual-foliated branched surfaces

- $\mathcal{B}_{A,Z} \subset S^3 \setminus (A \cup Z)$  is a dual-foliated branched surface associated to an iterated double pair  $(A, Z)$ .
- $L$  is an oriented link having a projection onto  $\mathcal{B}_{A,Z}$  such that the projection of  $L$  is transverse to both foliations of  $\mathcal{B}_{A,Z}$ .

## Oriented links carried by dual-foliated branched surfaces

- $\mathcal{B}_{A,Z} \subset S^3 \setminus (A \cup Z)$  is a dual-foliated branched surface associated to an iterated double pair  $(A, Z)$ .
- $L$  is an oriented link having a projection onto  $\mathcal{B}_{A,Z}$  such that the projection of  $L$  is transverse to both foliations of  $\mathcal{B}_{A,Z}$ .
- Then  $L$  is a closed braid  $L_A$  with respect to the axis  $A$  and fibration  $\{A(\theta)\}$ ; and, a closed braid  $L_Z$  with respect to the axis  $Z$  and the fibration  $\{Z(\phi)\}$ .

**Theorem 3 (Lafountain-Matsuda-M)** *Let  $L$  be carried by a dual-foliated branched surface  $\mathcal{B}_{A,Z}$  and suppose  $(A, Z)$  is a positive iterated doubling pair. Then the self-linking numbers for  $L_A$  and  $L_Z$  are equal. In particular, if the braid indexes are equal then their algebraic lengths are the same.*

**Theorem 3 (Lafountain-Matsuda-M)** *Let  $L$  be carried by a dual-foliated branched surface  $\mathcal{B}_{A,Z}$  and suppose  $(A, Z)$  is a positive iterated doubling pair. Then the self-linking numbers for  $L_A$  and  $L_Z$  are equal. In particular, if the braid indexes are equal then their algebraic lengths are the same.*

**Theorem 4 (Lafountain-Matsuda-M)** *Let  $L$  be carried by a dual-foliated branched surface  $\mathcal{B}_{A,Z}$  and suppose  $(A, Z)$  is a negative iterated doubling pair. Assume that braid indexes are both minimal then their self-linking number and, thus, algebraic lengths are the same.  $L_A$  and  $L_Z$  are equal.*

*Question: Given closed braid representations  $\beta, \beta'$  of an oriented link  $L$ , is there an iterated doubling pair  $(A, Z)$  such that the associated  $\mathcal{B}_{A,Z}$  carries  $L$  with  $L_A$  braid isotopic to  $\beta$  and  $L_Z$  braid isotopic to  $\beta'$ ?*



*Question: Given closed braid representations  $\beta, \beta'$  of an oriented link  $L$ , is there an iterated doubling pair  $(A, Z)$  such that the associated  $\mathcal{B}_{A,Z}$  carries  $L$  with  $L_A$  braid isotopic to  $\beta$  and  $L_Z$  braid isotopic to  $\beta'$ ?*

*Answer: Almost.*

**Theorem 5 (Lafountain-Matsuda-M, preliminary version)** *Let  $\beta, \beta'$  be two closed braid representatives of an oriented link  $L$ . Then there exists a  $\beta''$  such that:*

- 1.  $\beta''$  is obtained from  $\beta'$  through a sequence of destabilizations, exchange moves and braid isotopies.*
- 2. There is an iterated doubling pair  $(A, Z)$  such that the associated  $\mathcal{B}_{A, Z}$  carries  $L$ .*
- 3.  $L_A$  is braid isotopic to  $\beta$  and  $L_Z$  is braid isotopic to  $\beta''$ .*